

1



FULL OF PATTERNS

フル・オブ・パターン

この度は FULL OF PATTERNS をご利用頂きまして誠にありがとうございます。
ご使用の前に下記の注意事項をお読み下さい。

●商品のご利用に際して

1. 本製品は、個人でのご使用に限らせて頂きます。
2. 販売する型紙の著作権は放棄しておりません。すべての型紙の著作権は弊社にあります。

●禁止事項

1. 本製品を賃貸、貸与、再販売、再配布等を行うこと、また本製品の販売の妨害になるような使用は営利、非営利を問わず一切できません。
2. 法律に違反するような行為、公序良俗に反する行為、名誉毀損行為等での使用はできません。

●免責

1. 当方は、本製品に関して如何なる保証も行いません。
2. 本製品を使用した場合に発生した如何なる損害に対しても、当方は一切責任を負いません。

●ご利用手順

1. プリンターの設定を、A4 縦、100%(拡大縮小無し)、モノクロ(カラー部分はあります) にして下さい。詳しい設定方法はプリンターの取扱説明書をご覧ください。
- 2.1 枚目(この書類)と2 枚目(全体レイアウト縮小版)をプリントアウトし、下記の定規が原寸大で表示されているかをご確認下さい。
- 3.2 枚目(全体レイアウト縮小版)を見ながら、必要な仕様書とパーツを選んでプリントアウトして下さい。
4. 各パーツごとに破線———を重ね合わせて貼り合わせて下さい。隣り合わせの書類が1cm 重なる設定でレイアウトしてあります。
5. 型紙には縫代が付いています。一番外側の線に沿って切り取ってご使用下さい。

●その他

「折り伏せ縫い」「巻き縫い」部分を普通のロック始末&地縫いに変更したい場合は、縫代を幅の細い方(通常は1cm)に合わせて切り取って下さい。

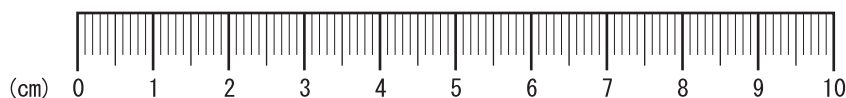

発売元: ヴィッツ・インターナショナル

〒500-8323 岐阜県岐阜市鹿島町8丁目43 錦声ビル3F

電話番号: 058-251-1799 FAX番号: 058-251-2652

E-Mail: fullofpatterns@witz-int.com

全体レイアウト縮小版

2

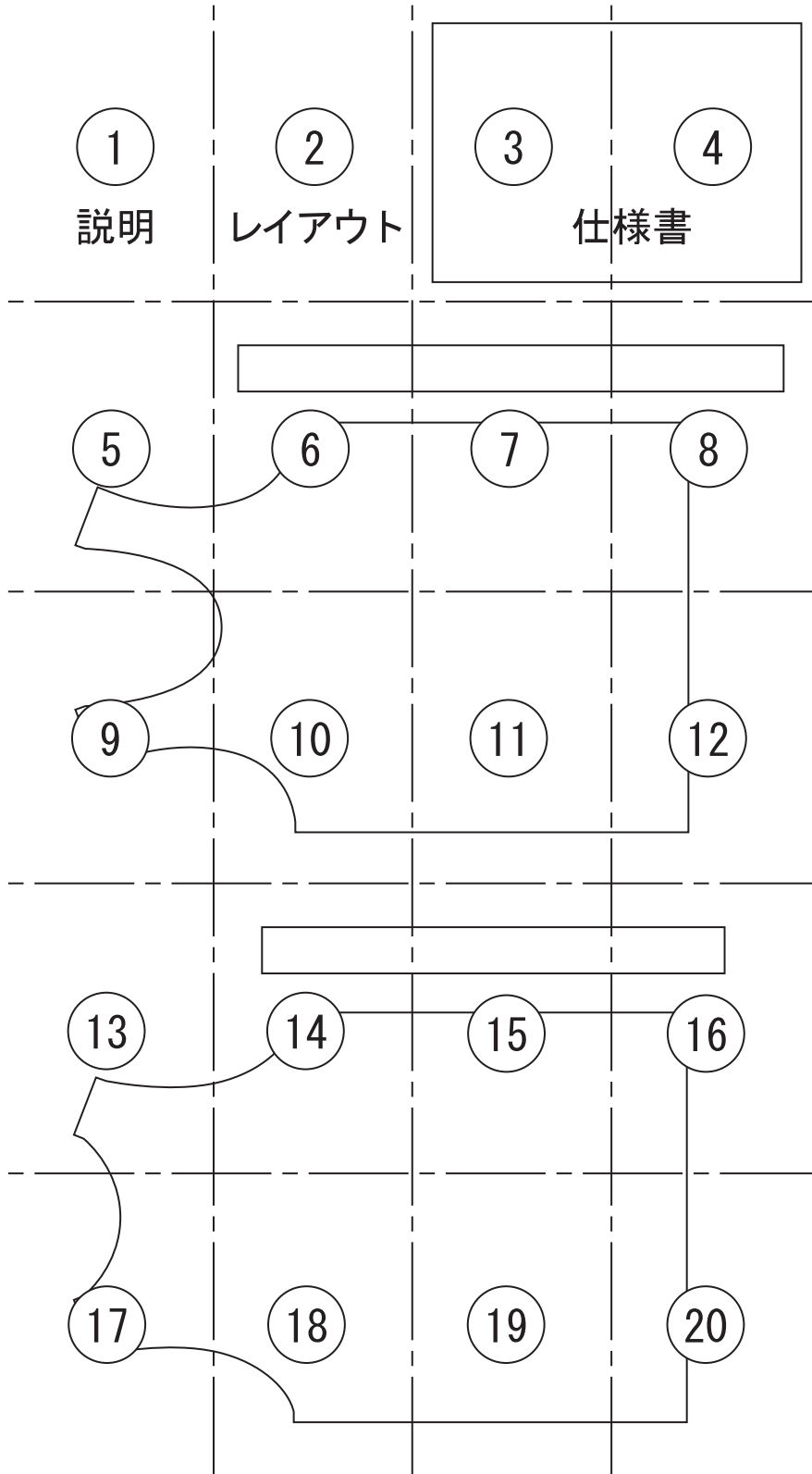

FULL OF PATTERNS

フルオブパターン ヴィッツ・インターナショナル
 〒500-8323 岐阜県岐阜市鹿島町8丁目43 錦声ビル3F
 電話番号：058-251-1799 FAX番号：058-251-2652
 E-Mail：fullpatterns@witz-int.com

縫製仕様書

作成日

パターンNO. FOP-K19	品名	タンクトップ	カテゴリ	キッズ	パーツ数																																																																																																																																																																																																														
<table border="1"> <thead> <tr> <th colspan="2">規格寸法 (cm)</th> <th colspan="4">ネーム類明細</th> <th colspan="2">裁断・縫製仕様</th> </tr> <tr> <th>名称</th> <th>サイズ</th> <th>品名</th> <th>品番</th> <th>規格</th> <th>数量</th> <th>仕入先</th> <th>型入れ</th> </tr> </thead> <tbody> <tr> <td>1</td> <td>身丈</td> <td>ネーム</td> <td></td> <td></td> <td></td> <td></td> <td>差込み可・一方向</td> </tr> <tr> <td>2</td> <td>身幅</td> <td>サイズネーム</td> <td></td> <td></td> <td></td> <td></td> <td>無し・有り ()</td> </tr> <tr> <td>3</td> <td>裾幅</td> <td>品質表示</td> <td></td> <td></td> <td></td> <td></td> <td>糸番手 / 針目 /</td> </tr> <tr> <td>4</td> <td>肩幅</td> <td>下札</td> <td></td> <td></td> <td></td> <td></td> <td>糸番手 / 針目 /</td> </tr> <tr> <td>5</td> <td>鎌深</td> <td></td> <td></td> <td></td> <td></td> <td></td> <td>後加工</td> </tr> <tr> <td>6</td> <td>内天幅</td> <td></td> <td></td> <td></td> <td></td> <td></td> <td>仕上げ</td> </tr> <tr> <td>7</td> <td>前下がり</td> <td colspan="4" rowspan="3">附属明細</td> <td></td> <td></td> </tr> <tr> <td>8</td> <td>後下がり</td> <td>品名</td> <td>規格</td> <td>数量</td> <td>使用箇所</td> <td></td> </tr> <tr> <td>9</td> <td>バインダー幅</td> <td></td> <td></td> <td></td> <td></td> <td></td> </tr> <tr> <td>10</td> <td></td> <td></td> <td></td> <td></td> <td></td> <td></td> <td></td> </tr> <tr> <td>11</td> <td></td> <td></td> <td></td> <td></td> <td></td> <td></td> <td></td> </tr> <tr> <td>12</td> <td></td> <td></td> <td></td> <td></td> <td></td> <td></td> <td></td> </tr> <tr> <td>13</td> <td></td> <td></td> <td></td> <td></td> <td></td> <td></td> <td></td> </tr> <tr> <td>14</td> <td></td> <td></td> <td></td> <td></td> <td></td> <td></td> <td></td> </tr> <tr> <td>15</td> <td></td> <td></td> <td></td> <td></td> <td></td> <td></td> <td></td> </tr> <tr> <td>16</td> <td></td> <td></td> <td></td> <td></td> <td></td> <td></td> <td></td> </tr> <tr> <td>17</td> <td></td> <td></td> <td></td> <td></td> <td></td> <td></td> <td></td> </tr> <tr> <td>18</td> <td></td> <td></td> <td></td> <td></td> <td></td> <td></td> <td></td> </tr> <tr> <td>19</td> <td></td> <td></td> <td></td> <td></td> <td></td> <td></td> <td></td> </tr> <tr> <td>20</td> <td></td> <td></td> <td></td> <td></td> <td></td> <td></td> <td></td> </tr> <tr> <td>21</td> <td></td> <td></td> <td></td> <td></td> <td></td> <td></td> <td></td> </tr> <tr> <td>22</td> <td></td> <td></td> <td></td> <td></td> <td></td> <td></td> <td></td> </tr> <tr> <td>23</td> <td></td> <td></td> <td></td> <td></td> <td></td> <td></td> <td></td> </tr> <tr> <td>24</td> <td></td> <td></td> <td></td> <td></td> <td></td> <td></td> <td></td> </tr> </tbody> </table>						規格寸法 (cm)		ネーム類明細				裁断・縫製仕様		名称	サイズ	品名	品番	規格	数量	仕入先	型入れ	1	身丈	ネーム					差込み可・一方向	2	身幅	サイズネーム					無し・有り ()	3	裾幅	品質表示					糸番手 / 針目 /	4	肩幅	下札					糸番手 / 針目 /	5	鎌深						後加工	6	内天幅						仕上げ	7	前下がり	附属明細						8	後下がり	品名	規格	数量	使用箇所		9	バインダー幅						10								11								12								13								14								15								16								17								18								19								20								21								22								23								24							
規格寸法 (cm)		ネーム類明細				裁断・縫製仕様																																																																																																																																																																																																													
名称	サイズ	品名	品番	規格	数量	仕入先	型入れ																																																																																																																																																																																																												
1	身丈	ネーム					差込み可・一方向																																																																																																																																																																																																												
2	身幅	サイズネーム					無し・有り ()																																																																																																																																																																																																												
3	裾幅	品質表示					糸番手 / 針目 /																																																																																																																																																																																																												
4	肩幅	下札					糸番手 / 針目 /																																																																																																																																																																																																												
5	鎌深						後加工																																																																																																																																																																																																												
6	内天幅						仕上げ																																																																																																																																																																																																												
7	前下がり	附属明細																																																																																																																																																																																																																	
8	後下がり					品名	規格	数量	使用箇所																																																																																																																																																																																																										
9	バインダー幅																																																																																																																																																																																																																		
10																																																																																																																																																																																																																			
11																																																																																																																																																																																																																			
12																																																																																																																																																																																																																			
13																																																																																																																																																																																																																			
14																																																																																																																																																																																																																			
15																																																																																																																																																																																																																			
16																																																																																																																																																																																																																			
17																																																																																																																																																																																																																			
18																																																																																																																																																																																																																			
19																																																																																																																																																																																																																			
20																																																																																																																																																																																																																			
21																																																																																																																																																																																																																			
22																																																																																																																																																																																																																			
23																																																																																																																																																																																																																			
24																																																																																																																																																																																																																			
<p>特記事項</p> <p>※型紙には洗いによる縮み分は入っていません。 素材により異なりますが、5～10%程度の縮み分を プラスされるか、裁断前に生地を水洗いする 事をお勧めします。</p>																																																																																																																																																																																																																			

表生地四つ折りバインダー始末
 仕上り1.0cm～1.5cm(ボテサイズによって変わります)
 コバ+5mmダブルステッチ押え

衿バインダー
 左側ネックでつなぐ

袖ぐりバインダー
 脇下でつなぐ

裾二つ折り始末
 20mm+5mmダブルステッチ

5

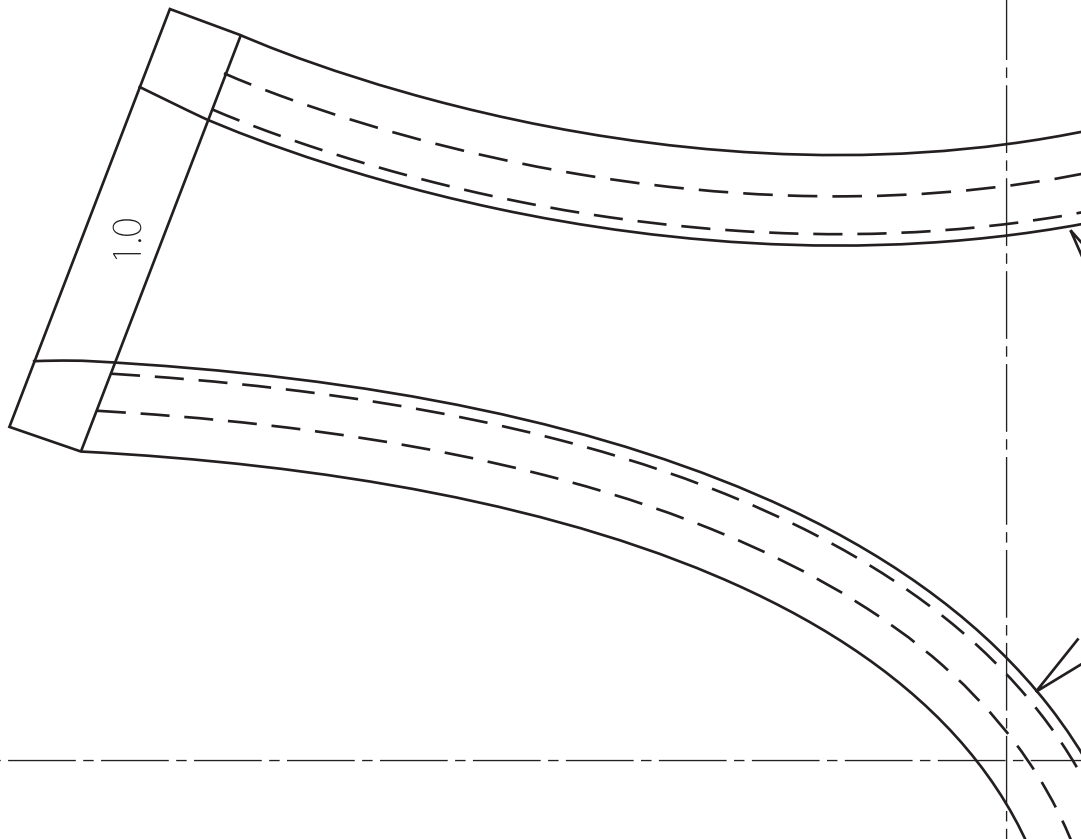

6

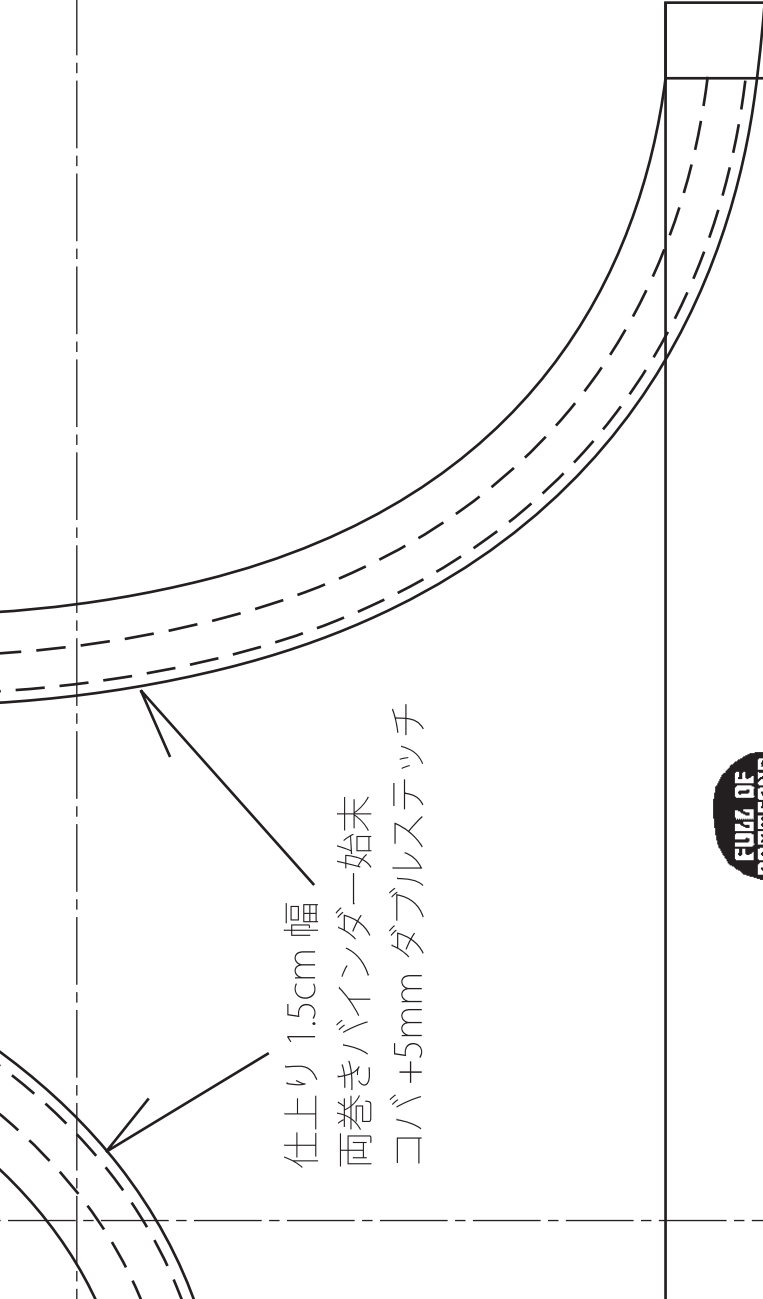
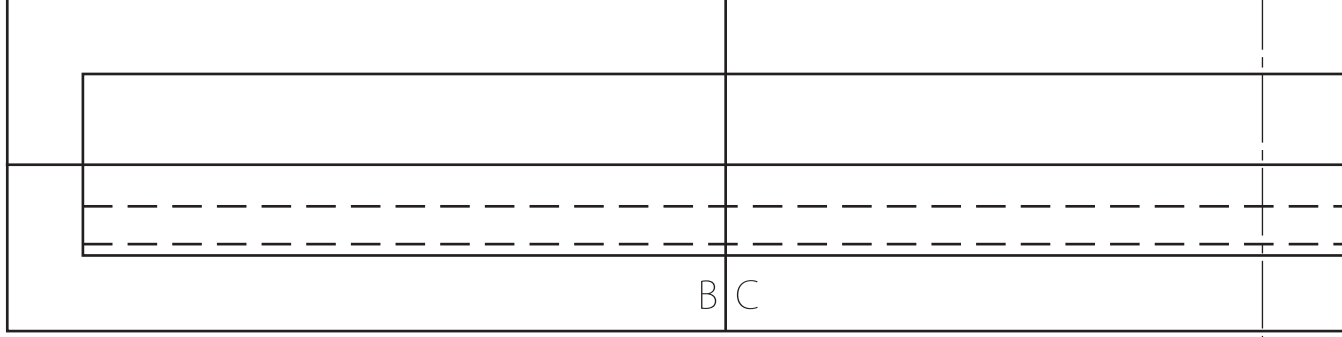

仕上り 1.5cm 幅
両巻きバインダー始末
コバ +5mm ダブルステッチ



FOP-K19
Size:130
前身頃
(表1枚)

7

FOP-K19/Size:130
衿バインダー布(表1枚)

1.0

F C

1.0

20mm+5mm
ダブルステッチ

8

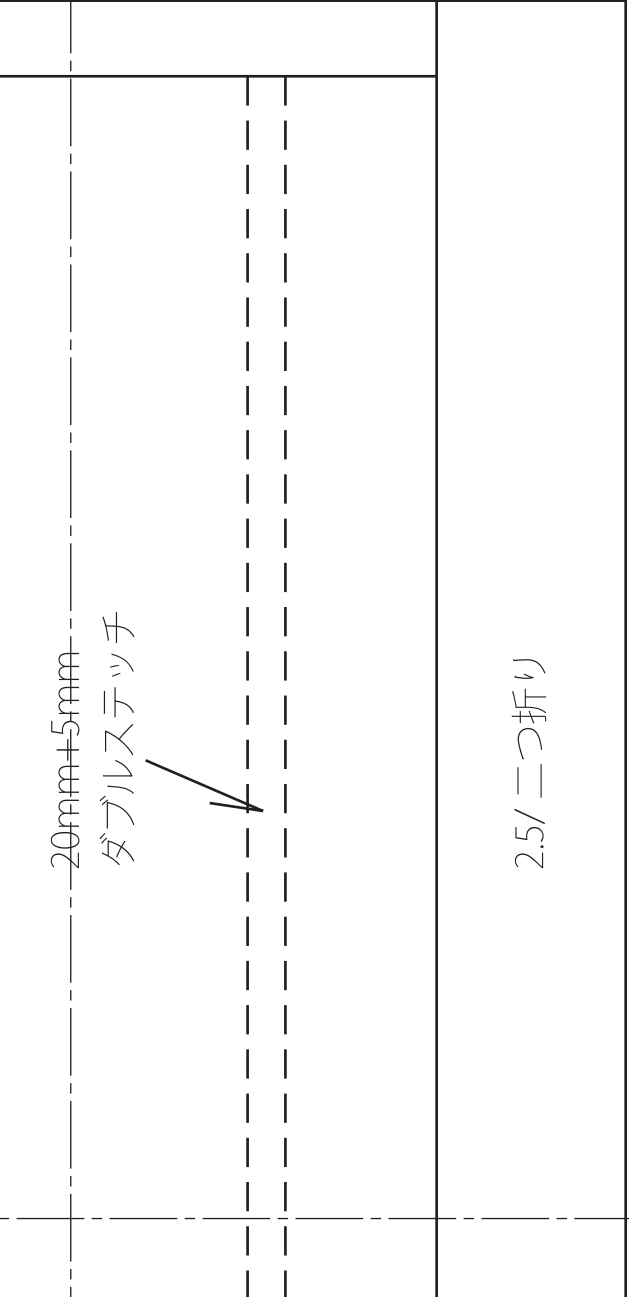
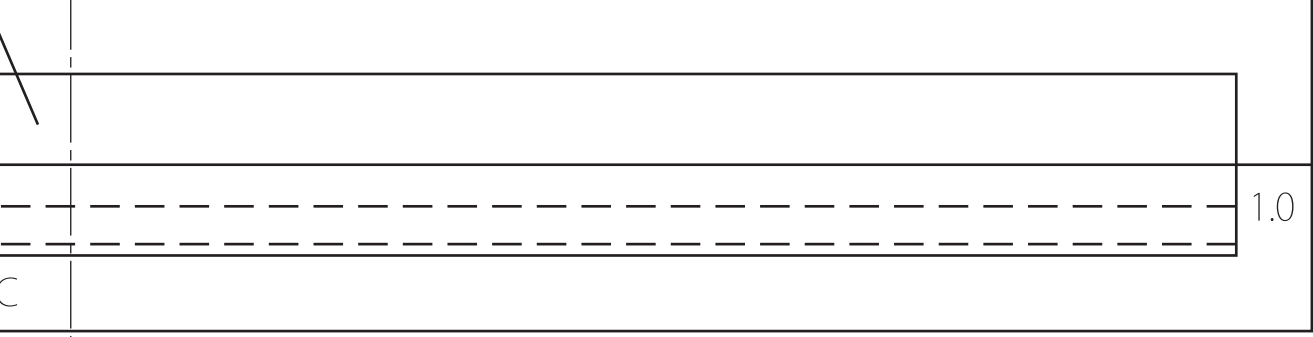

9

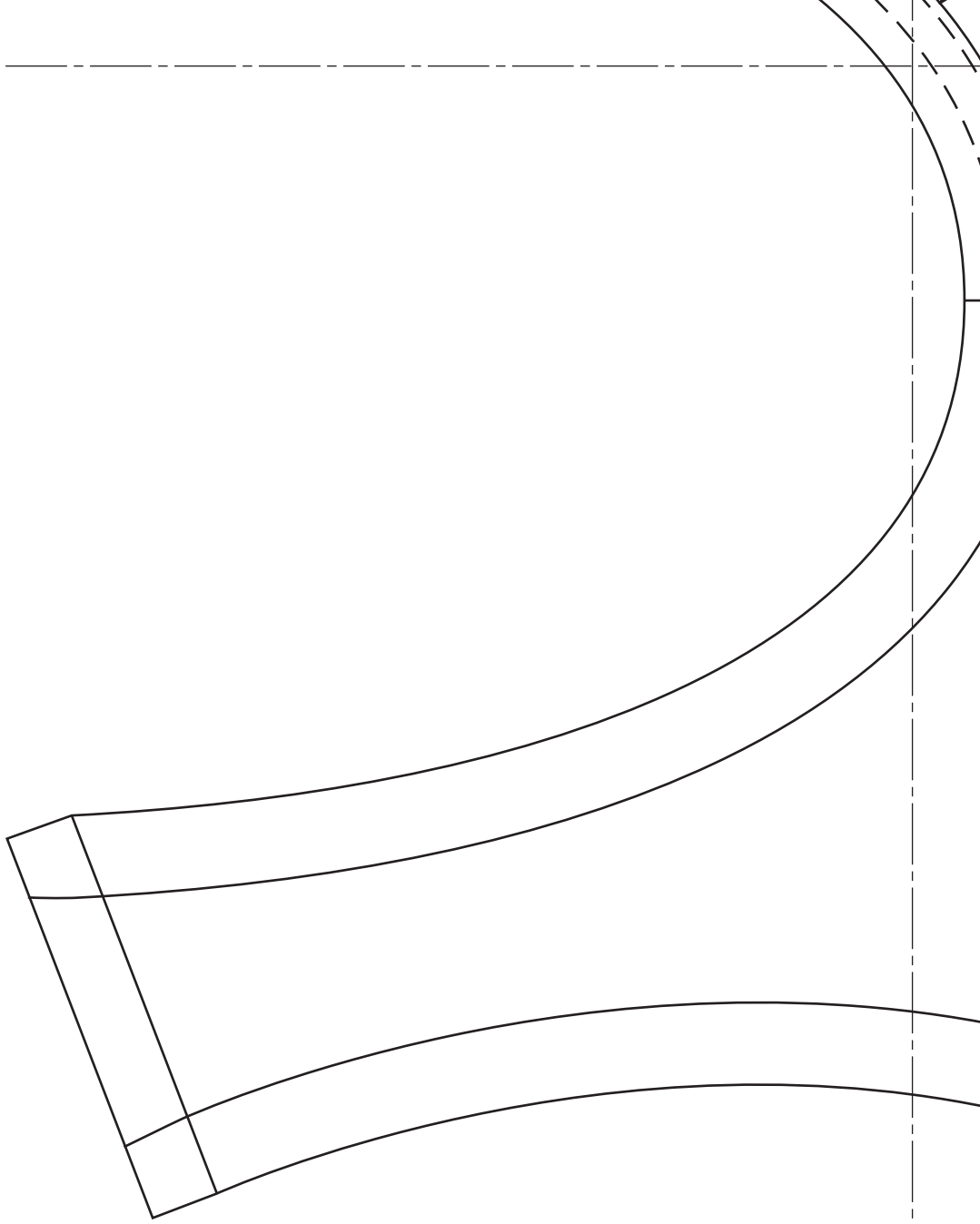

FC

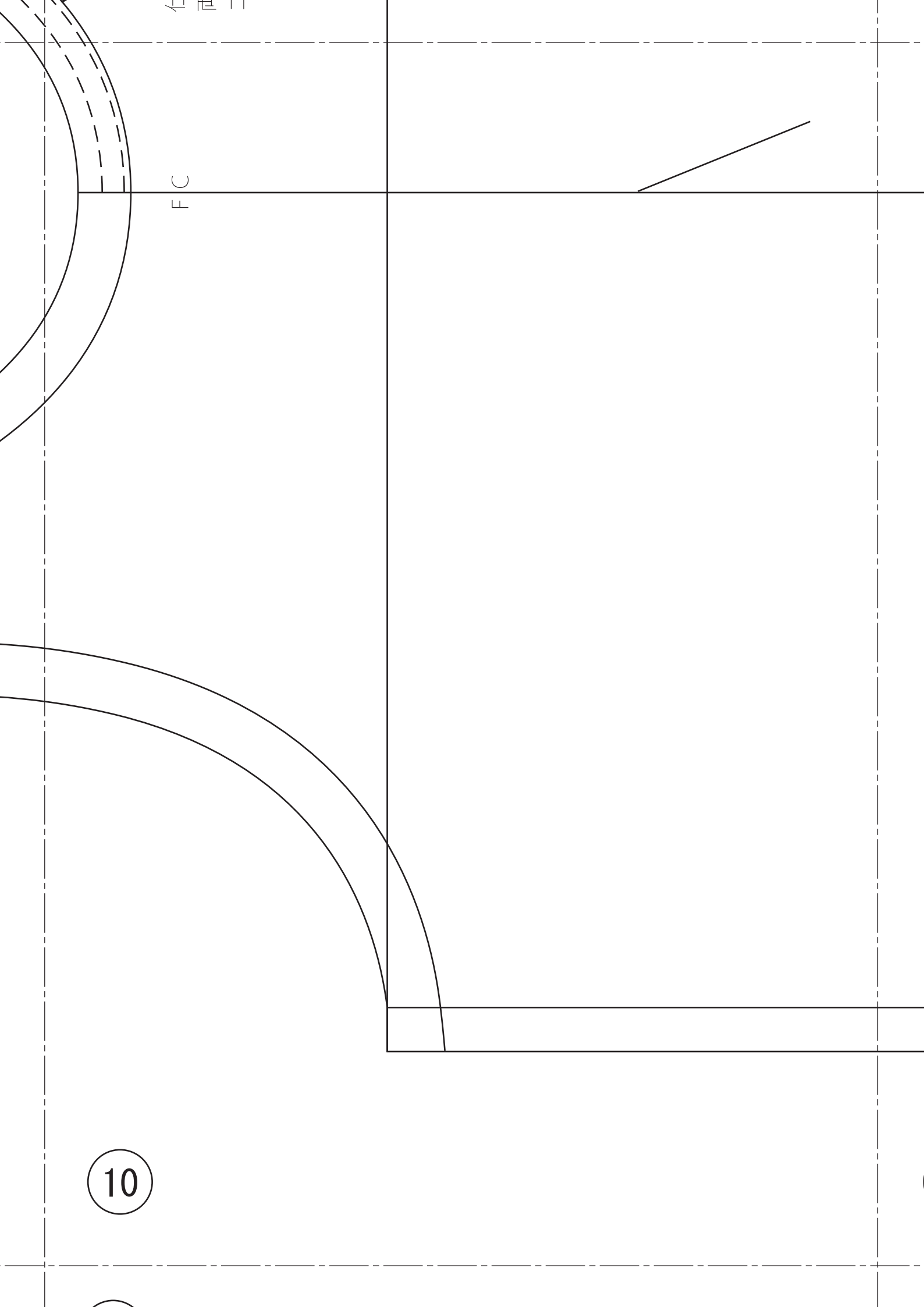

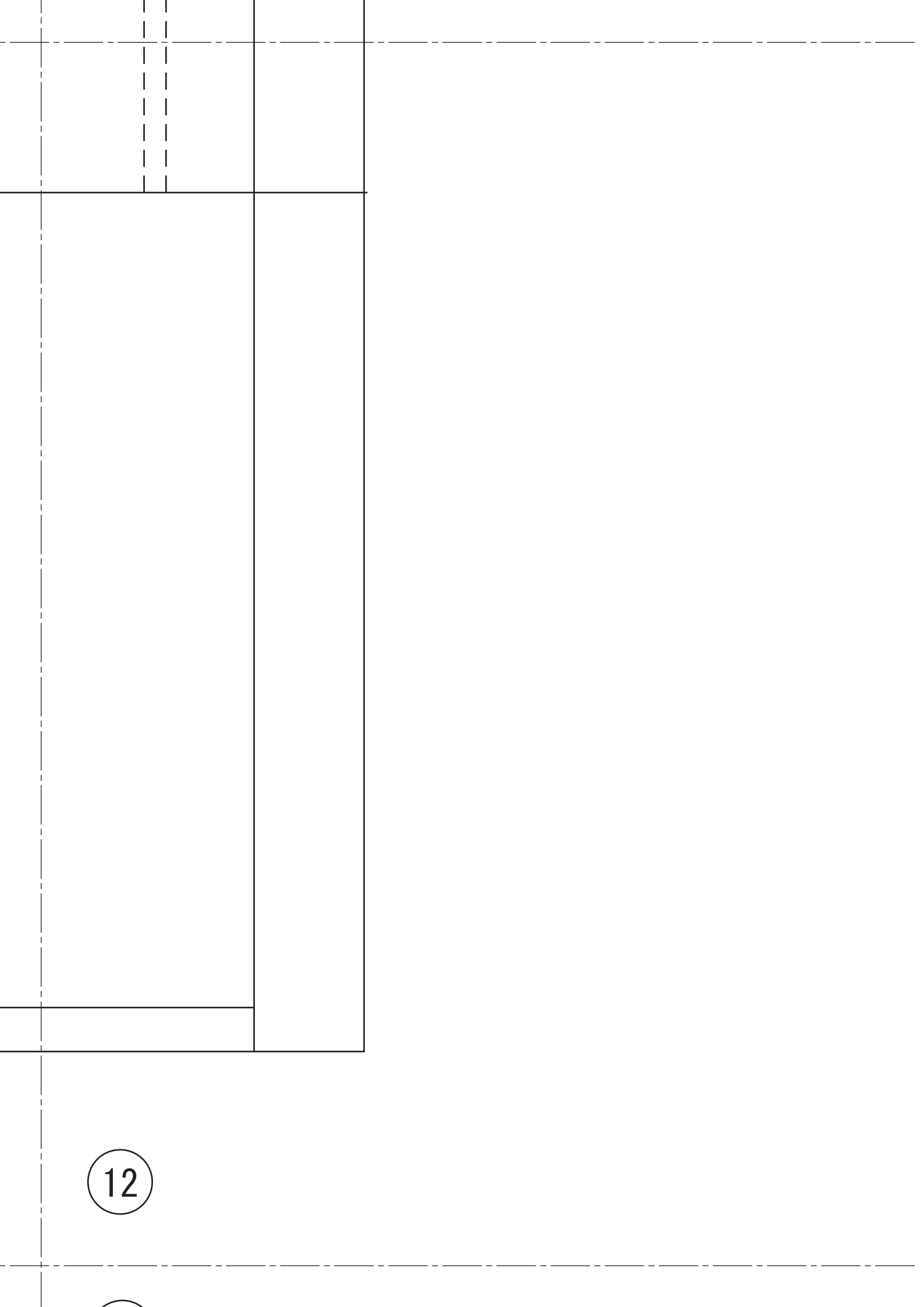

12

13

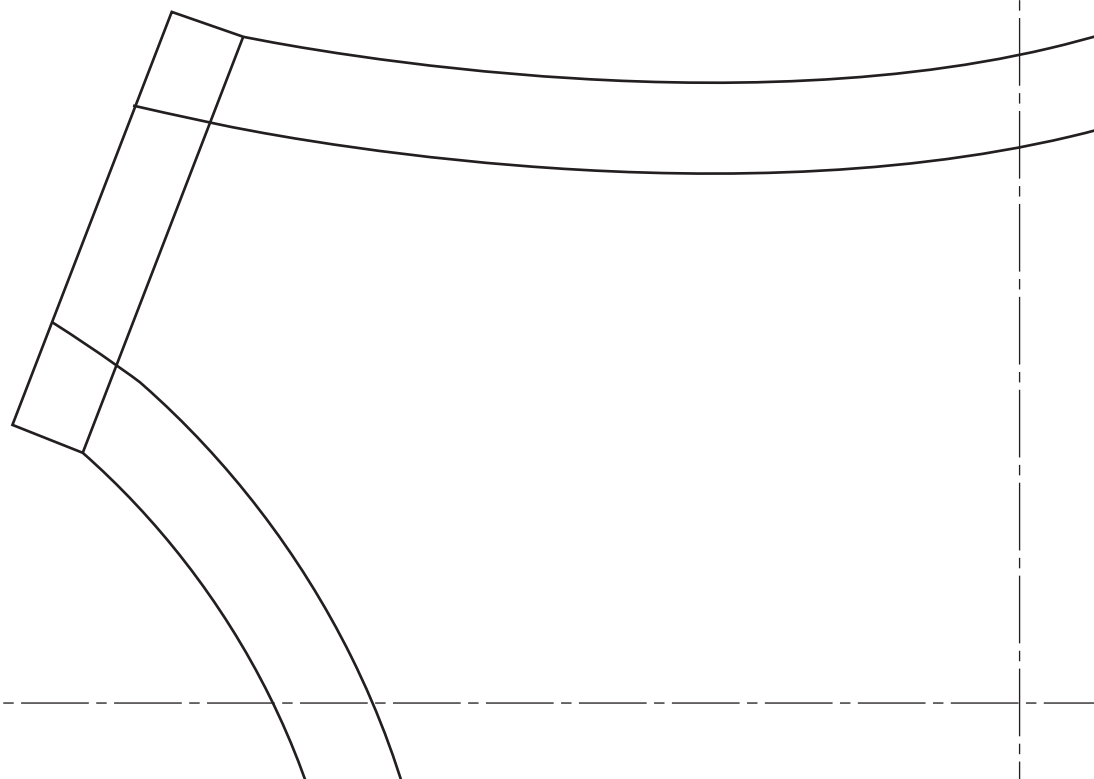

14

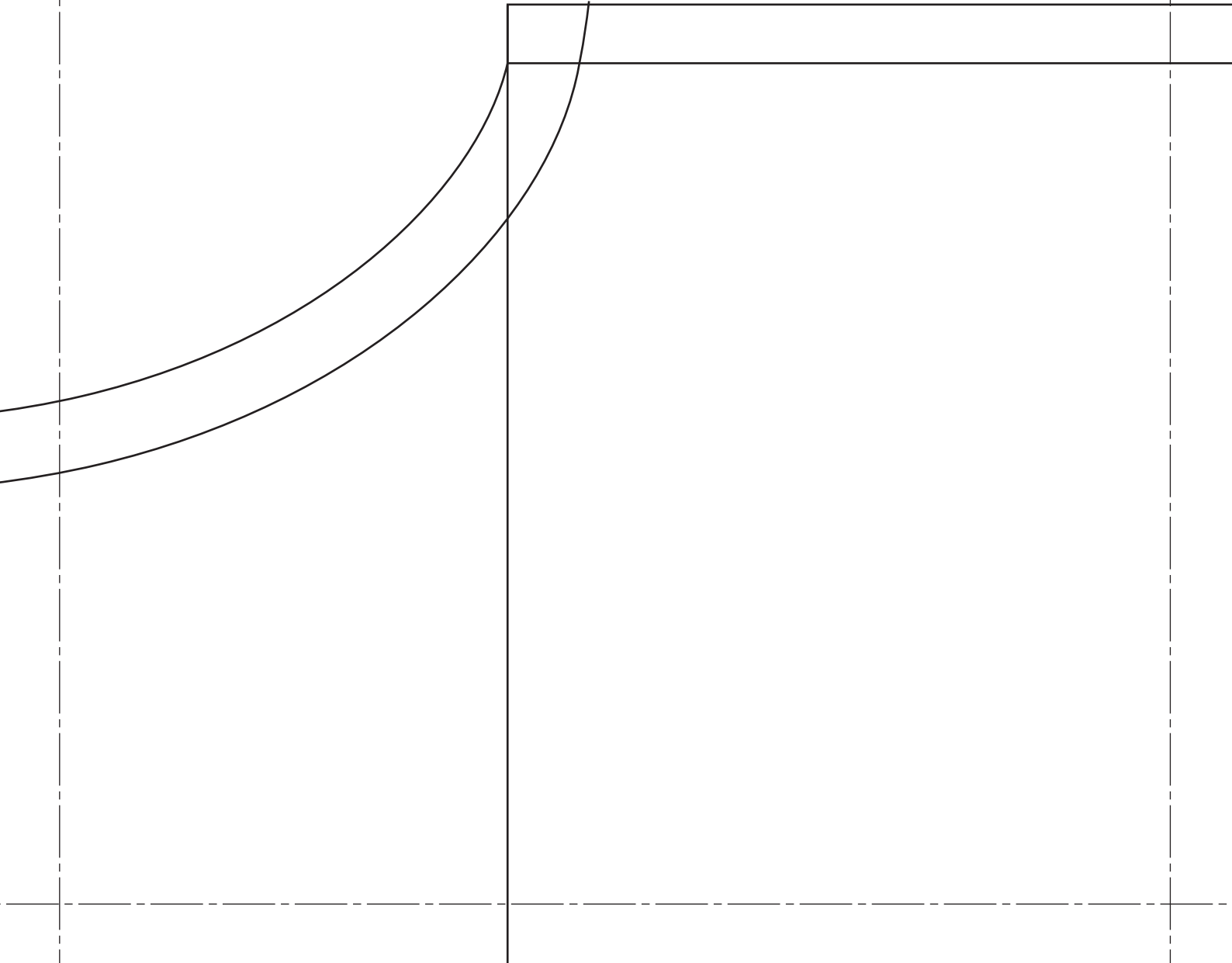
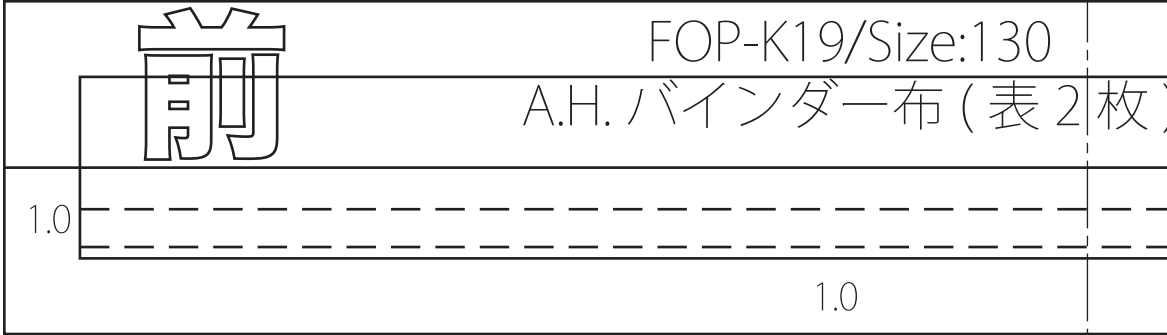

15

60
長 2 枚)

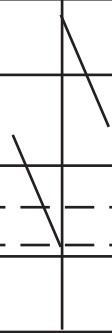

16

後

1.0

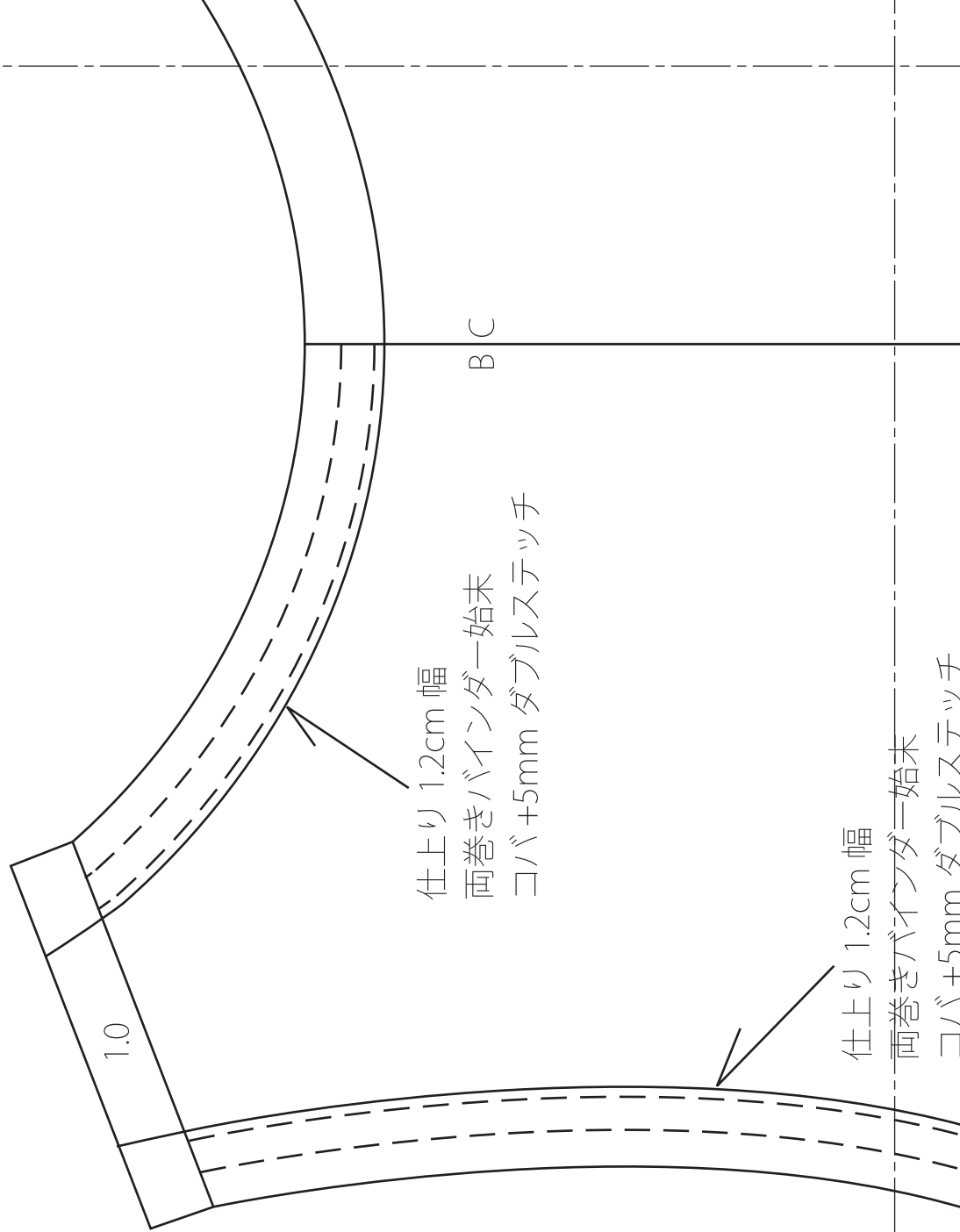

仕上り 1.2cm 幅

両巻きバイアンダ=始末

コバ+5mm ダブルステッチ

18



FOP-K19

Size:130

後身頃
(表1枚)

1.0

20mm±5mm
ダブルステッチ

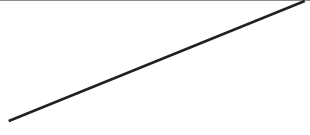

20mm±5mm

ダブルステッチ

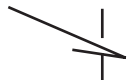

2.5/ 二つ折り