

1



FULL OF PATTERNS

フル・オブ・パターン

この度は FULL OF PATTERNS をご利用頂きまして誠にありがとうございます。
ご使用の前に下記の注意事項をお読み下さい。

●商品のご利用に際して

1. 本製品は、個人でのご使用に限らせて頂きます。
2. 販売する型紙の著作権は放棄しておりません。すべての型紙の著作権は弊社にあります。

●禁止事項

1. 本製品を賃貸、貸与、再販売、再配布等を行うこと、また本製品の販売の妨害になるような使用は営利、非営利を問わず一切できません。
2. 法律に違反するような行為、公序良俗に反する行為、名誉毀損行為等での使用はできません。

●免責

1. 当方は、本製品に関して如何なる保証も行いません。
2. 本製品を使用した場合に発生した如何なる損害に対しても、当方は一切責任を負いません。

●ご利用手順

1. プリンターの設定を、A4 縦、100% (拡大縮小無し)、モノクロ (カラー部分はありませぬ) にして下さい。詳しい設定方法はプリンターの取扱説明書をご覧下さい。
2. 1 枚目 (この書類) と 2 枚目 (全体レイアウト縮小版) をプリントアウトし、下記の定規が原寸大で表示されているかをご確認下さい。
3. 2 枚目 (全体レイアウト縮小版) を見ながら、必要な仕様書とパーツを選んでプリントアウトして下さい。
4. 各パーツごとに破線———を重ね合わせて貼り合わせて下さい。隣り合わせの書類が 1cm 重なる設定でレイアウトしてあります。
5. 型紙には縫代が付いています。一番外側の線に沿って切り取ってご使用下さい。

●その他

「折り伏せ縫い」「巻き縫い」部分を普通のロック始末&地縫いに変更したい場合は、縫代を幅の細い方 (通常は 1cm) に合わせて切り取って下さい。



FULL OF PATTERNS

<http://witz-int.com/fulllofpatterns/index.html>

お問合せ : fulllofdesigns@witz-int.com

全体レイアウト縮小版

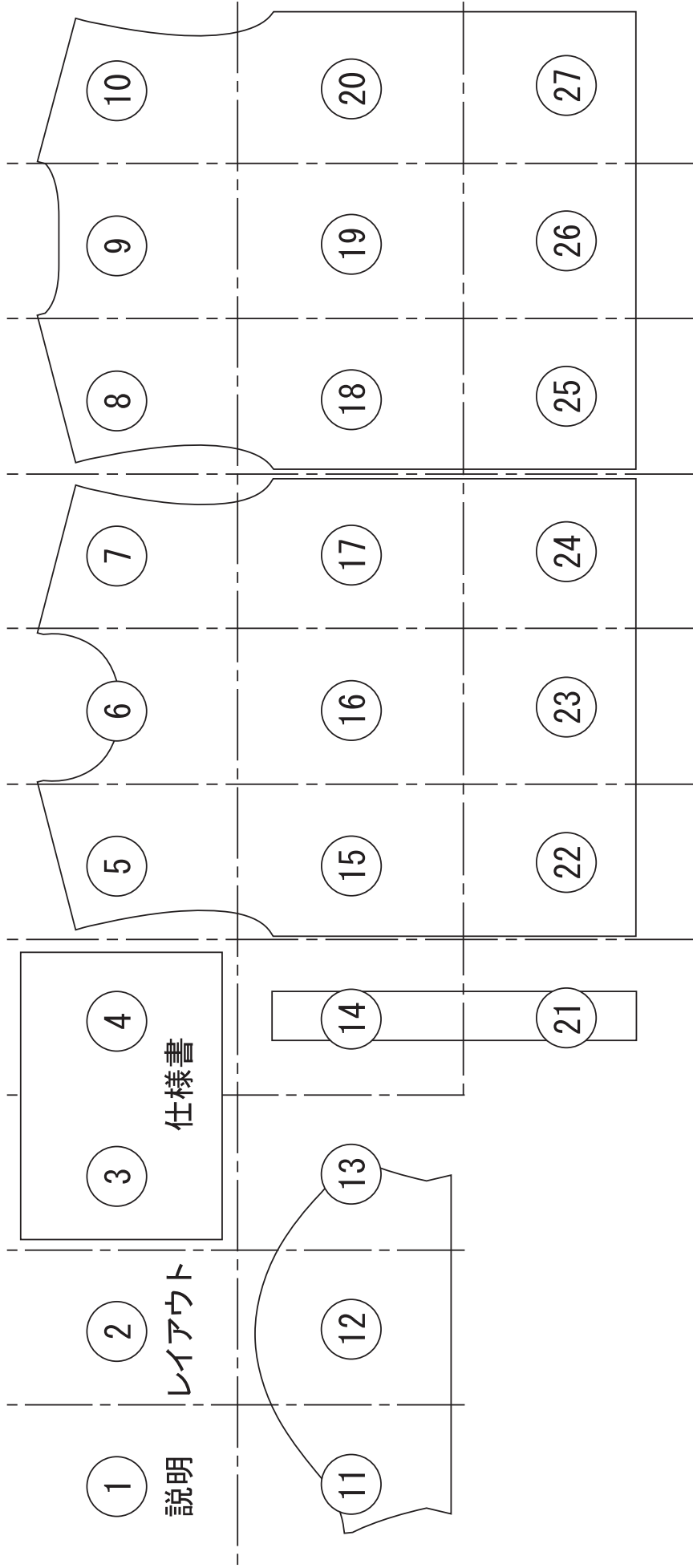

FULL OF PATTERNS

フル・オブ・パターン ヴィッツ・インターナショナル
 〒500-8323 岐阜県岐阜市鹿島町8丁目43 錦声ビル3F
 電話番号：058-251-1799 FAX番号：058-251-2652
 E-Mail：fullpatterns@witz-int.com

縫製仕様書

作成日

| パターンNO. FOP-11T | 品名 | 半袖Tシャツ | カテゴリ | メンズ | パーツ数 | | | | | | | | | | | | | | | | | | | | | | | | | | | | | | | | | | | | | | | | | | | | | | | | | | | | | | | | | | | | | | | | | | | | | | | | | | | | | | | | | | | | | | | | | | | | | | | | | | | | | | | | | | | | | | | | | | | | | | | | | | | | | | | | | | | | | | | | | | | | | | | | | | | | | | | | | | | | | | | | | | | | | | | | | | | | | | | | | | | | | | | | | | | | | | | | | | | | | | | | | | | | | | | | | |
|--|-----|--------|------|-----|------|-----------|----------------|--------|----|------|--|---------|--|----|-----|----|----|----|----|-----|-----|------|----|-----|--|--|--|--|-----------|------|----|--------|--|--|--|--|----------------|------|----|------|--|--|--|--|--------------|------|----|----|--|--|--|--|---------------|------|----|--|--|--|--|--|-----|------|----|--|--|--|--|--|-----|------|----|------|--|--|--|--|--|--|-------|----|----|----|----|------|--|--|---------|----|--|--|--|--|--|--|---------|----|--|--|--|--|--|--|---------|----|--|--|--|--|--|--|-------|-----|--|--|--|--|--|--|----|---|--|--|--|--|--|--|----|--|--|--|--|--|--|--|----|--|--|--|--|--|--|--|----|--|--|--|--|--|--|--|----|--|--|--|--|--|--|--|----|--|--|--|--|--|--|--|----|--|--|--|--|--|--|--|----|--|--|--|--|--|--|--|----|--|--|--|--|--|--|--|----|--|--|--|--|--|--|--|----|--|--|--|--|--|--|--|----|--|--|--|--|--|--|--|
| <table border="1"> <thead> <tr> <th colspan="2">規格寸法 (cm)</th> <th colspan="4">ネーム類明細</th> <th colspan="2">裁断・縫製仕様</th> </tr> <tr> <th>名称</th> <th>サイズ</th> <th>品名</th> <th>品番</th> <th>規格</th> <th>数量</th> <th>仕入先</th> <th>型入れ</th> </tr> </thead> <tbody> <tr> <td>1 着丈</td> <td>XL</td> <td>ネーム</td> <td></td> <td></td> <td></td> <td></td> <td>差込み可・一方方向</td> </tr> <tr> <td>2 身幅</td> <td>69</td> <td>サイズネーム</td> <td></td> <td></td> <td></td> <td></td> <td>柄合わせ 無し・有り ()</td> </tr> <tr> <td>3 裾幅</td> <td>54</td> <td>品質表示</td> <td></td> <td></td> <td></td> <td></td> <td>地縫い 糸番手/ 針目/</td> </tr> <tr> <td>4 肩幅</td> <td>54</td> <td>下札</td> <td></td> <td></td> <td></td> <td></td> <td>ステッチ 糸番手/ 針目/</td> </tr> <tr> <td>5 袖丈</td> <td>52</td> <td></td> <td></td> <td></td> <td></td> <td></td> <td>後加工</td> </tr> <tr> <td>6 桁丈</td> <td>20</td> <td></td> <td></td> <td></td> <td></td> <td></td> <td>仕上げ</td> </tr> <tr> <td>7 袖幅</td> <td>46</td> <td colspan="5" rowspan="2">附属明細</td> <td></td> <td></td> </tr> <tr> <td>8 袖口幅</td> <td>22</td> <td>品名</td> <td>規格</td> <td>数量</td> <td>使用箇所</td> <td></td> <td></td> </tr> <tr> <td>9 天幅(外)</td> <td>19</td> <td></td> <td></td> <td></td> <td></td> <td></td> <td></td> </tr> <tr> <td>10 前下がり</td> <td>20</td> <td></td> <td></td> <td></td> <td></td> <td></td> <td></td> </tr> <tr> <td>11 後下がり</td> <td>10</td> <td></td> <td></td> <td></td> <td></td> <td></td> <td></td> </tr> <tr> <td>12 衿幅</td> <td>2.5</td> <td></td> <td></td> <td></td> <td></td> <td></td> <td></td> </tr> <tr> <td>13</td> <td>2</td> <td></td> <td></td> <td></td> <td></td> <td></td> <td></td> </tr> <tr> <td>14</td> <td></td> <td></td> <td></td> <td></td> <td></td> <td></td> <td></td> </tr> <tr> <td>15</td> <td></td> <td></td> <td></td> <td></td> <td></td> <td></td> <td></td> </tr> <tr> <td>16</td> <td></td> <td></td> <td></td> <td></td> <td></td> <td></td> <td></td> </tr> <tr> <td>17</td> <td></td> <td></td> <td></td> <td></td> <td></td> <td></td> <td></td> </tr> <tr> <td>18</td> <td></td> <td></td> <td></td> <td></td> <td></td> <td></td> <td></td> </tr> <tr> <td>19</td> <td></td> <td></td> <td></td> <td></td> <td></td> <td></td> <td></td> </tr> <tr> <td>20</td> <td></td> <td></td> <td></td> <td></td> <td></td> <td></td> <td></td> </tr> <tr> <td>21</td> <td></td> <td></td> <td></td> <td></td> <td></td> <td></td> <td></td> </tr> <tr> <td>22</td> <td></td> <td></td> <td></td> <td></td> <td></td> <td></td> <td></td> </tr> <tr> <td>23</td> <td></td> <td></td> <td></td> <td></td> <td></td> <td></td> <td></td> </tr> <tr> <td>24</td> <td></td> <td></td> <td></td> <td></td> <td></td> <td></td> <td></td> </tr> </tbody> </table> | | | | | | 規格寸法 (cm) | | ネーム類明細 | | | | 裁断・縫製仕様 | | 名称 | サイズ | 品名 | 品番 | 規格 | 数量 | 仕入先 | 型入れ | 1 着丈 | XL | ネーム | | | | | 差込み可・一方方向 | 2 身幅 | 69 | サイズネーム | | | | | 柄合わせ 無し・有り () | 3 裾幅 | 54 | 品質表示 | | | | | 地縫い 糸番手/ 針目/ | 4 肩幅 | 54 | 下札 | | | | | ステッチ 糸番手/ 針目/ | 5 袖丈 | 52 | | | | | | 後加工 | 6 桁丈 | 20 | | | | | | 仕上げ | 7 袖幅 | 46 | 附属明細 | | | | | | | 8 袖口幅 | 22 | 品名 | 規格 | 数量 | 使用箇所 | | | 9 天幅(外) | 19 | | | | | | | 10 前下がり | 20 | | | | | | | 11 後下がり | 10 | | | | | | | 12 衿幅 | 2.5 | | | | | | | 13 | 2 | | | | | | | 14 | | | | | | | | 15 | | | | | | | | 16 | | | | | | | | 17 | | | | | | | | 18 | | | | | | | | 19 | | | | | | | | 20 | | | | | | | | 21 | | | | | | | | 22 | | | | | | | | 23 | | | | | | | | 24 | | | | | | | |
| 規格寸法 (cm) | | ネーム類明細 | | | | 裁断・縫製仕様 | | | | | | | | | | | | | | | | | | | | | | | | | | | | | | | | | | | | | | | | | | | | | | | | | | | | | | | | | | | | | | | | | | | | | | | | | | | | | | | | | | | | | | | | | | | | | | | | | | | | | | | | | | | | | | | | | | | | | | | | | | | | | | | | | | | | | | | | | | | | | | | | | | | | | | | | | | | | | | | | | | | | | | | | | | | | | | | | | | | | | | | | | | | | | | | | | | | | | | | | | | | | | | | | |
| 名称 | サイズ | 品名 | 品番 | 規格 | 数量 | 仕入先 | 型入れ | | | | | | | | | | | | | | | | | | | | | | | | | | | | | | | | | | | | | | | | | | | | | | | | | | | | | | | | | | | | | | | | | | | | | | | | | | | | | | | | | | | | | | | | | | | | | | | | | | | | | | | | | | | | | | | | | | | | | | | | | | | | | | | | | | | | | | | | | | | | | | | | | | | | | | | | | | | | | | | | | | | | | | | | | | | | | | | | | | | | | | | | | | | | | | | | | | | | | | | | | | | | | | | |
| 1 着丈 | XL | ネーム | | | | | 差込み可・一方方向 | | | | | | | | | | | | | | | | | | | | | | | | | | | | | | | | | | | | | | | | | | | | | | | | | | | | | | | | | | | | | | | | | | | | | | | | | | | | | | | | | | | | | | | | | | | | | | | | | | | | | | | | | | | | | | | | | | | | | | | | | | | | | | | | | | | | | | | | | | | | | | | | | | | | | | | | | | | | | | | | | | | | | | | | | | | | | | | | | | | | | | | | | | | | | | | | | | | | | | | | | | | | | | | |
| 2 身幅 | 69 | サイズネーム | | | | | 柄合わせ 無し・有り () | | | | | | | | | | | | | | | | | | | | | | | | | | | | | | | | | | | | | | | | | | | | | | | | | | | | | | | | | | | | | | | | | | | | | | | | | | | | | | | | | | | | | | | | | | | | | | | | | | | | | | | | | | | | | | | | | | | | | | | | | | | | | | | | | | | | | | | | | | | | | | | | | | | | | | | | | | | | | | | | | | | | | | | | | | | | | | | | | | | | | | | | | | | | | | | | | | | | | | | | | | | | | | | |
| 3 裾幅 | 54 | 品質表示 | | | | | 地縫い 糸番手/ 針目/ | | | | | | | | | | | | | | | | | | | | | | | | | | | | | | | | | | | | | | | | | | | | | | | | | | | | | | | | | | | | | | | | | | | | | | | | | | | | | | | | | | | | | | | | | | | | | | | | | | | | | | | | | | | | | | | | | | | | | | | | | | | | | | | | | | | | | | | | | | | | | | | | | | | | | | | | | | | | | | | | | | | | | | | | | | | | | | | | | | | | | | | | | | | | | | | | | | | | | | | | | | | | | | | |
| 4 肩幅 | 54 | 下札 | | | | | ステッチ 糸番手/ 針目/ | | | | | | | | | | | | | | | | | | | | | | | | | | | | | | | | | | | | | | | | | | | | | | | | | | | | | | | | | | | | | | | | | | | | | | | | | | | | | | | | | | | | | | | | | | | | | | | | | | | | | | | | | | | | | | | | | | | | | | | | | | | | | | | | | | | | | | | | | | | | | | | | | | | | | | | | | | | | | | | | | | | | | | | | | | | | | | | | | | | | | | | | | | | | | | | | | | | | | | | | | | | | | | | |
| 5 袖丈 | 52 | | | | | | 後加工 | | | | | | | | | | | | | | | | | | | | | | | | | | | | | | | | | | | | | | | | | | | | | | | | | | | | | | | | | | | | | | | | | | | | | | | | | | | | | | | | | | | | | | | | | | | | | | | | | | | | | | | | | | | | | | | | | | | | | | | | | | | | | | | | | | | | | | | | | | | | | | | | | | | | | | | | | | | | | | | | | | | | | | | | | | | | | | | | | | | | | | | | | | | | | | | | | | | | | | | | | | | | | | | |
| 6 桁丈 | 20 | | | | | | 仕上げ | | | | | | | | | | | | | | | | | | | | | | | | | | | | | | | | | | | | | | | | | | | | | | | | | | | | | | | | | | | | | | | | | | | | | | | | | | | | | | | | | | | | | | | | | | | | | | | | | | | | | | | | | | | | | | | | | | | | | | | | | | | | | | | | | | | | | | | | | | | | | | | | | | | | | | | | | | | | | | | | | | | | | | | | | | | | | | | | | | | | | | | | | | | | | | | | | | | | | | | | | | | | | | | |
| 7 袖幅 | 46 | 附属明細 | | | | | | | | | | | | | | | | | | | | | | | | | | | | | | | | | | | | | | | | | | | | | | | | | | | | | | | | | | | | | | | | | | | | | | | | | | | | | | | | | | | | | | | | | | | | | | | | | | | | | | | | | | | | | | | | | | | | | | | | | | | | | | | | | | | | | | | | | | | | | | | | | | | | | | | | | | | | | | | | | | | | | | | | | | | | | | | | | | | | | | | | | | | | | | | | | | | | | | | | | | | | | | | | | | | | |
| 8 袖口幅 | 22 | | | | | | 品名 | 規格 | 数量 | 使用箇所 | | | | | | | | | | | | | | | | | | | | | | | | | | | | | | | | | | | | | | | | | | | | | | | | | | | | | | | | | | | | | | | | | | | | | | | | | | | | | | | | | | | | | | | | | | | | | | | | | | | | | | | | | | | | | | | | | | | | | | | | | | | | | | | | | | | | | | | | | | | | | | | | | | | | | | | | | | | | | | | | | | | | | | | | | | | | | | | | | | | | | | | | | | | | | | | | | | | | | | | | | | | | |
| 9 天幅(外) | 19 | | | | | | | | | | | | | | | | | | | | | | | | | | | | | | | | | | | | | | | | | | | | | | | | | | | | | | | | | | | | | | | | | | | | | | | | | | | | | | | | | | | | | | | | | | | | | | | | | | | | | | | | | | | | | | | | | | | | | | | | | | | | | | | | | | | | | | | | | | | | | | | | | | | | | | | | | | | | | | | | | | | | | | | | | | | | | | | | | | | | | | | | | | | | | | | | | | | | | | | | | | | | | | | | | | | | | |
| 10 前下がり | 20 | | | | | | | | | | | | | | | | | | | | | | | | | | | | | | | | | | | | | | | | | | | | | | | | | | | | | | | | | | | | | | | | | | | | | | | | | | | | | | | | | | | | | | | | | | | | | | | | | | | | | | | | | | | | | | | | | | | | | | | | | | | | | | | | | | | | | | | | | | | | | | | | | | | | | | | | | | | | | | | | | | | | | | | | | | | | | | | | | | | | | | | | | | | | | | | | | | | | | | | | | | | | | | | | | | | | | |
| 11 後下がり | 10 | | | | | | | | | | | | | | | | | | | | | | | | | | | | | | | | | | | | | | | | | | | | | | | | | | | | | | | | | | | | | | | | | | | | | | | | | | | | | | | | | | | | | | | | | | | | | | | | | | | | | | | | | | | | | | | | | | | | | | | | | | | | | | | | | | | | | | | | | | | | | | | | | | | | | | | | | | | | | | | | | | | | | | | | | | | | | | | | | | | | | | | | | | | | | | | | | | | | | | | | | | | | | | | | | | | | | |
| 12 衿幅 | 2.5 | | | | | | | | | | | | | | | | | | | | | | | | | | | | | | | | | | | | | | | | | | | | | | | | | | | | | | | | | | | | | | | | | | | | | | | | | | | | | | | | | | | | | | | | | | | | | | | | | | | | | | | | | | | | | | | | | | | | | | | | | | | | | | | | | | | | | | | | | | | | | | | | | | | | | | | | | | | | | | | | | | | | | | | | | | | | | | | | | | | | | | | | | | | | | | | | | | | | | | | | | | | | | | | | | | | | | |
| 13 | 2 | | | | | | | | | | | | | | | | | | | | | | | | | | | | | | | | | | | | | | | | | | | | | | | | | | | | | | | | | | | | | | | | | | | | | | | | | | | | | | | | | | | | | | | | | | | | | | | | | | | | | | | | | | | | | | | | | | | | | | | | | | | | | | | | | | | | | | | | | | | | | | | | | | | | | | | | | | | | | | | | | | | | | | | | | | | | | | | | | | | | | | | | | | | | | | | | | | | | | | | | | | | | | | | | | | | | | |
| 14 | | | | | | | | | | | | | | | | | | | | | | | | | | | | | | | | | | | | | | | | | | | | | | | | | | | | | | | | | | | | | | | | | | | | | | | | | | | | | | | | | | | | | | | | | | | | | | | | | | | | | | | | | | | | | | | | | | | | | | | | | | | | | | | | | | | | | | | | | | | | | | | | | | | | | | | | | | | | | | | | | | | | | | | | | | | | | | | | | | | | | | | | | | | | | | | | | | | | | | | | | | | | | | | | | | | | | | |
| 15 | | | | | | | | | | | | | | | | | | | | | | | | | | | | | | | | | | | | | | | | | | | | | | | | | | | | | | | | | | | | | | | | | | | | | | | | | | | | | | | | | | | | | | | | | | | | | | | | | | | | | | | | | | | | | | | | | | | | | | | | | | | | | | | | | | | | | | | | | | | | | | | | | | | | | | | | | | | | | | | | | | | | | | | | | | | | | | | | | | | | | | | | | | | | | | | | | | | | | | | | | | | | | | | | | | | | | | |
| 16 | | | | | | | | | | | | | | | | | | | | | | | | | | | | | | | | | | | | | | | | | | | | | | | | | | | | | | | | | | | | | | | | | | | | | | | | | | | | | | | | | | | | | | | | | | | | | | | | | | | | | | | | | | | | | | | | | | | | | | | | | | | | | | | | | | | | | | | | | | | | | | | | | | | | | | | | | | | | | | | | | | | | | | | | | | | | | | | | | | | | | | | | | | | | | | | | | | | | | | | | | | | | | | | | | | | | | | |
| 17 | | | | | | | | | | | | | | | | | | | | | | | | | | | | | | | | | | | | | | | | | | | | | | | | | | | | | | | | | | | | | | | | | | | | | | | | | | | | | | | | | | | | | | | | | | | | | | | | | | | | | | | | | | | | | | | | | | | | | | | | | | | | | | | | | | | | | | | | | | | | | | | | | | | | | | | | | | | | | | | | | | | | | | | | | | | | | | | | | | | | | | | | | | | | | | | | | | | | | | | | | | | | | | | | | | | | | | |
| 18 | | | | | | | | | | | | | | | | | | | | | | | | | | | | | | | | | | | | | | | | | | | | | | | | | | | | | | | | | | | | | | | | | | | | | | | | | | | | | | | | | | | | | | | | | | | | | | | | | | | | | | | | | | | | | | | | | | | | | | | | | | | | | | | | | | | | | | | | | | | | | | | | | | | | | | | | | | | | | | | | | | | | | | | | | | | | | | | | | | | | | | | | | | | | | | | | | | | | | | | | | | | | | | | | | | | | | | |
| 19 | | | | | | | | | | | | | | | | | | | | | | | | | | | | | | | | | | | | | | | | | | | | | | | | | | | | | | | | | | | | | | | | | | | | | | | | | | | | | | | | | | | | | | | | | | | | | | | | | | | | | | | | | | | | | | | | | | | | | | | | | | | | | | | | | | | | | | | | | | | | | | | | | | | | | | | | | | | | | | | | | | | | | | | | | | | | | | | | | | | | | | | | | | | | | | | | | | | | | | | | | | | | | | | | | | | | | | |
| 20 | | | | | | | | | | | | | | | | | | | | | | | | | | | | | | | | | | | | | | | | | | | | | | | | | | | | | | | | | | | | | | | | | | | | | | | | | | | | | | | | | | | | | | | | | | | | | | | | | | | | | | | | | | | | | | | | | | | | | | | | | | | | | | | | | | | | | | | | | | | | | | | | | | | | | | | | | | | | | | | | | | | | | | | | | | | | | | | | | | | | | | | | | | | | | | | | | | | | | | | | | | | | | | | | | | | | | | |
| 21 | | | | | | | | | | | | | | | | | | | | | | | | | | | | | | | | | | | | | | | | | | | | | | | | | | | | | | | | | | | | | | | | | | | | | | | | | | | | | | | | | | | | | | | | | | | | | | | | | | | | | | | | | | | | | | | | | | | | | | | | | | | | | | | | | | | | | | | | | | | | | | | | | | | | | | | | | | | | | | | | | | | | | | | | | | | | | | | | | | | | | | | | | | | | | | | | | | | | | | | | | | | | | | | | | | | | | | |
| 22 | | | | | | | | | | | | | | | | | | | | | | | | | | | | | | | | | | | | | | | | | | | | | | | | | | | | | | | | | | | | | | | | | | | | | | | | | | | | | | | | | | | | | | | | | | | | | | | | | | | | | | | | | | | | | | | | | | | | | | | | | | | | | | | | | | | | | | | | | | | | | | | | | | | | | | | | | | | | | | | | | | | | | | | | | | | | | | | | | | | | | | | | | | | | | | | | | | | | | | | | | | | | | | | | | | | | | | |
| 23 | | | | | | | | | | | | | | | | | | | | | | | | | | | | | | | | | | | | | | | | | | | | | | | | | | | | | | | | | | | | | | | | | | | | | | | | | | | | | | | | | | | | | | | | | | | | | | | | | | | | | | | | | | | | | | | | | | | | | | | | | | | | | | | | | | | | | | | | | | | | | | | | | | | | | | | | | | | | | | | | | | | | | | | | | | | | | | | | | | | | | | | | | | | | | | | | | | | | | | | | | | | | | | | | | | | | | | |
| 24 | | | | | | | | | | | | | | | | | | | | | | | | | | | | | | | | | | | | | | | | | | | | | | | | | | | | | | | | | | | | | | | | | | | | | | | | | | | | | | | | | | | | | | | | | | | | | | | | | | | | | | | | | | | | | | | | | | | | | | | | | | | | | | | | | | | | | | | | | | | | | | | | | | | | | | | | | | | | | | | | | | | | | | | | | | | | | | | | | | | | | | | | | | | | | | | | | | | | | | | | | | | | | | | | | | | | | | |
| <p>特記事項</p> <p>※型紙には洗いによる縮み分は入っていません。 素材により異なりますが、5～10%程度の縮み分を プラスされるか、裁断前に生地を水洗いする 事をお勧めします。</p> | | | | | | | | | | | | | | | | | | | | | | | | | | | | | | | | | | | | | | | | | | | | | | | | | | | | | | | | | | | | | | | | | | | | | | | | | | | | | | | | | | | | | | | | | | | | | | | | | | | | | | | | | | | | | | | | | | | | | | | | | | | | | | | | | | | | | | | | | | | | | | | | | | | | | | | | | | | | | | | | | | | | | | | | | | | | | | | | | | | | | | | | | | | | | | | | | | | | | | | | | | | | | | | | | | | | | | |

衿リブは型紙上で20%伸ばして付ける仕様になっています。
 素材により若干の差がありますので、ご注意ください。

衿リブは型紙上で20%伸ばして付ける仕様になっています。
素材により若干の差がありますので、ご注意下さい。

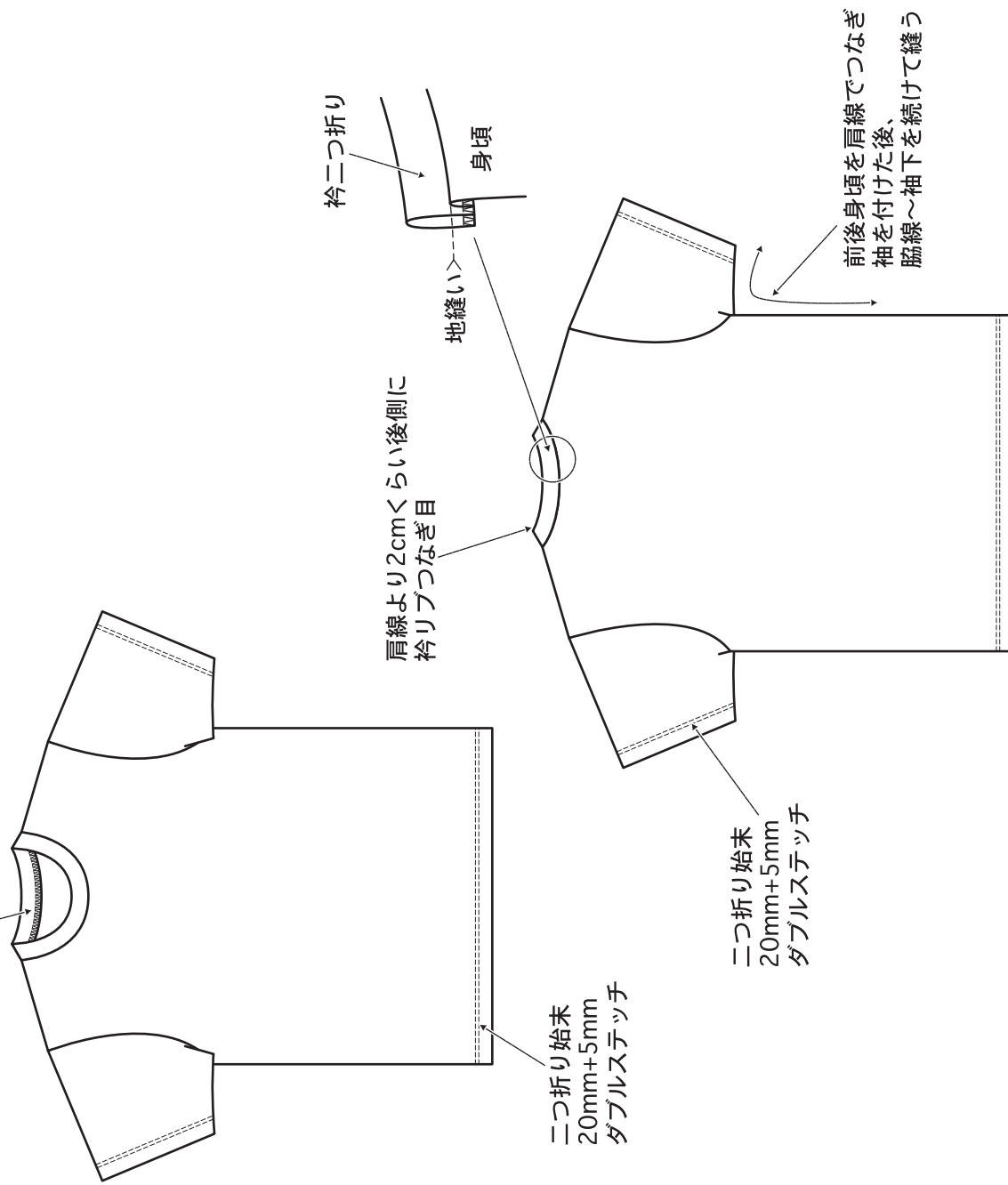

5

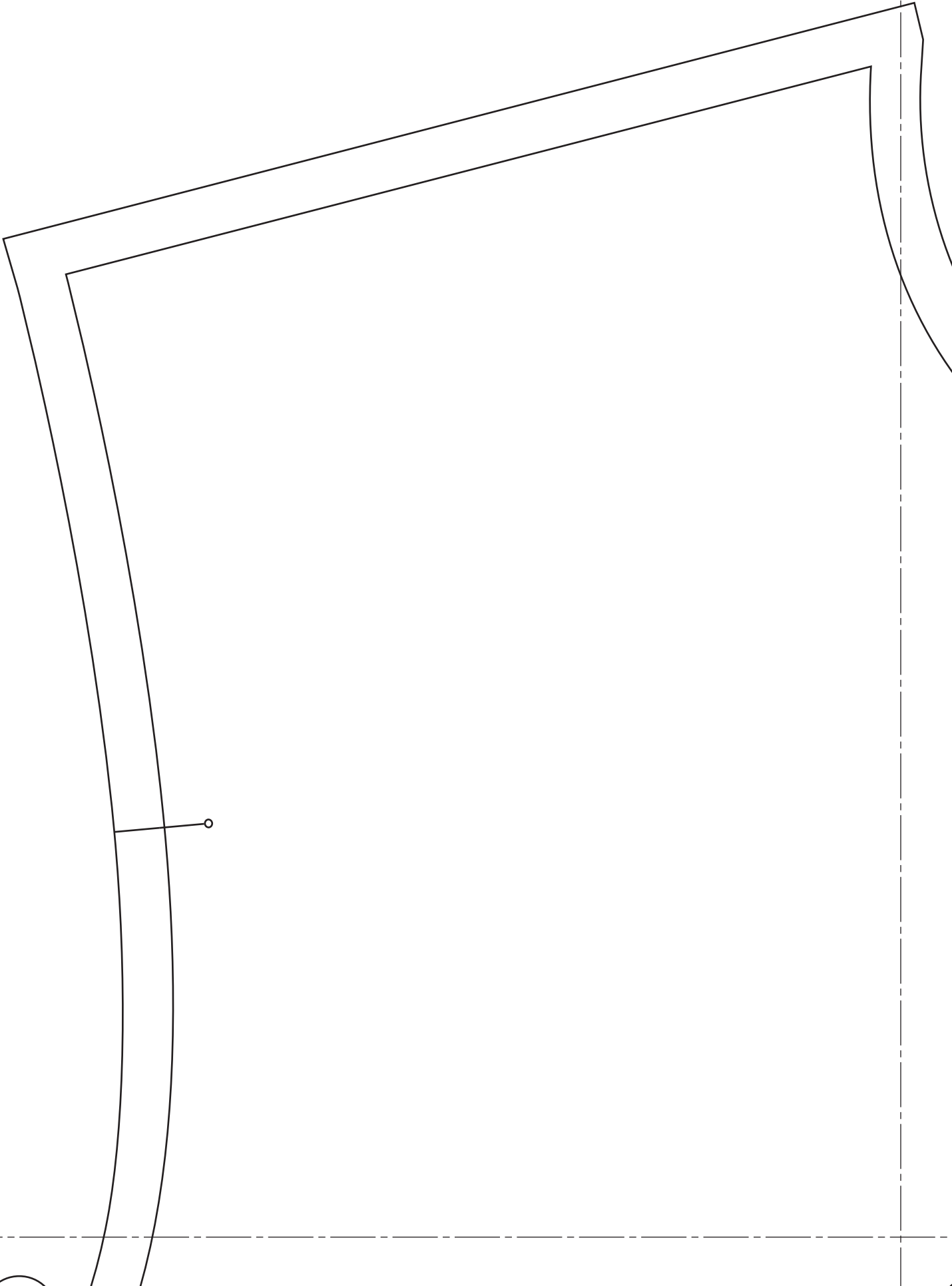

6

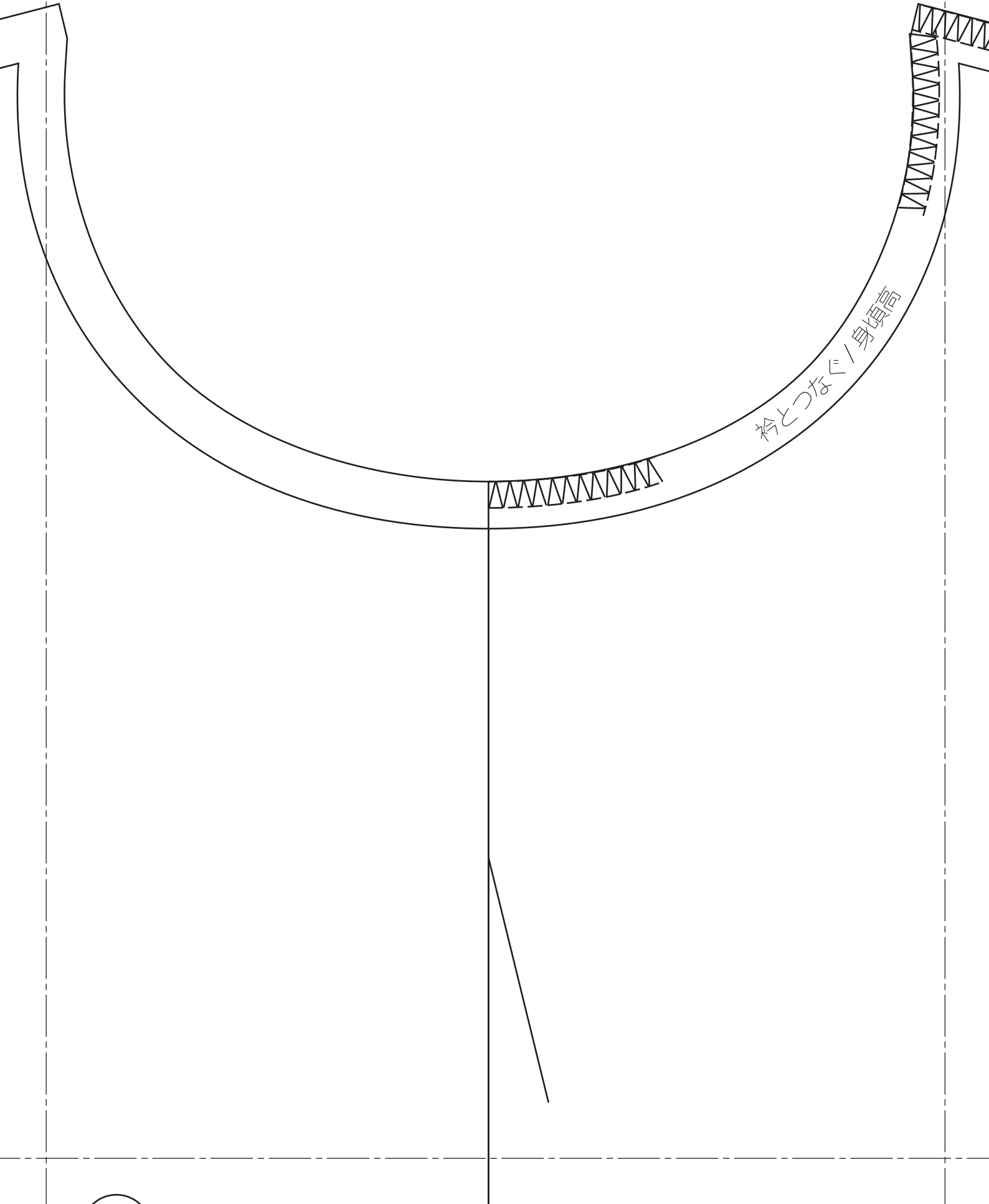

衿とつながる身頃高

7

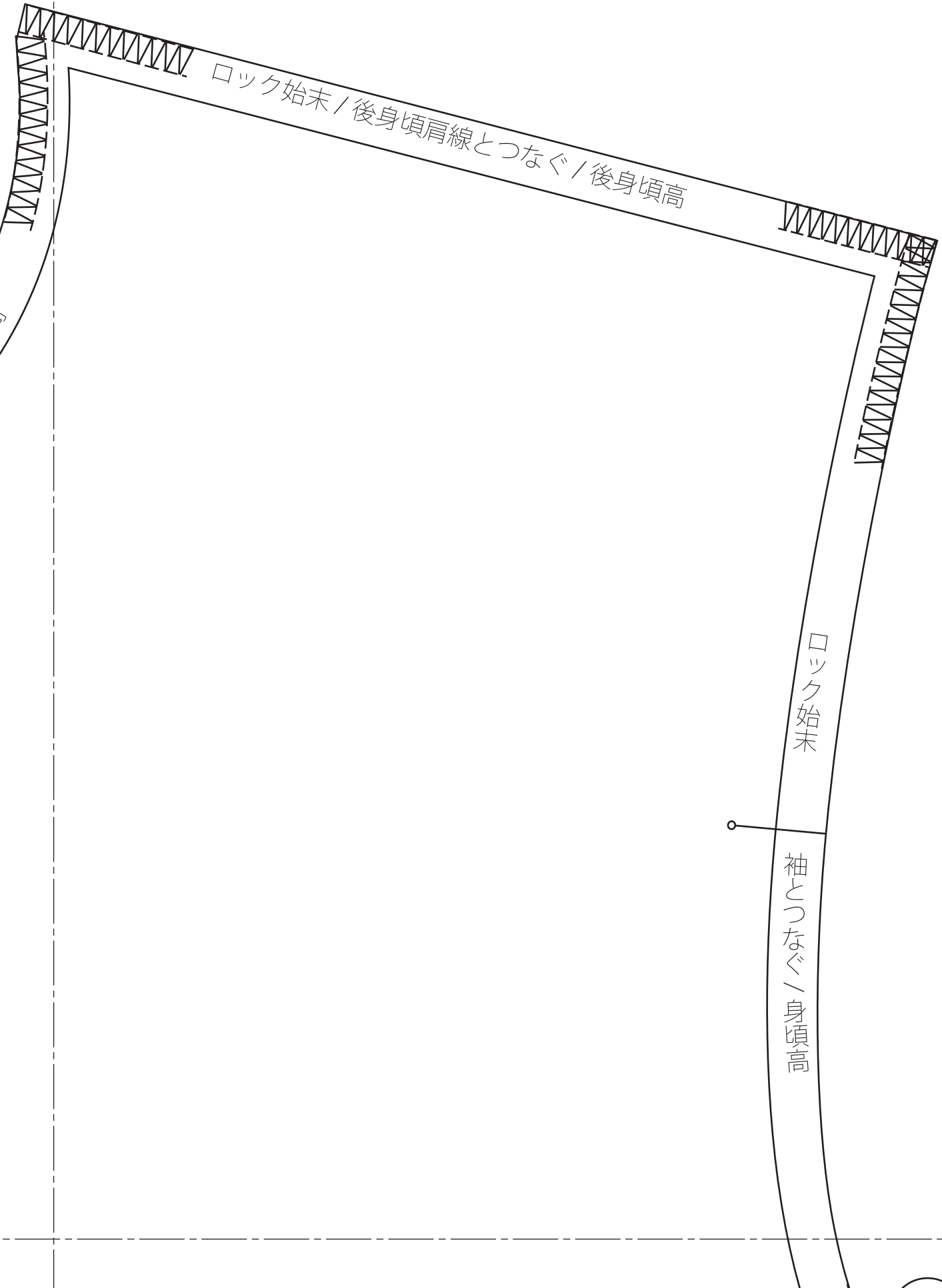

8

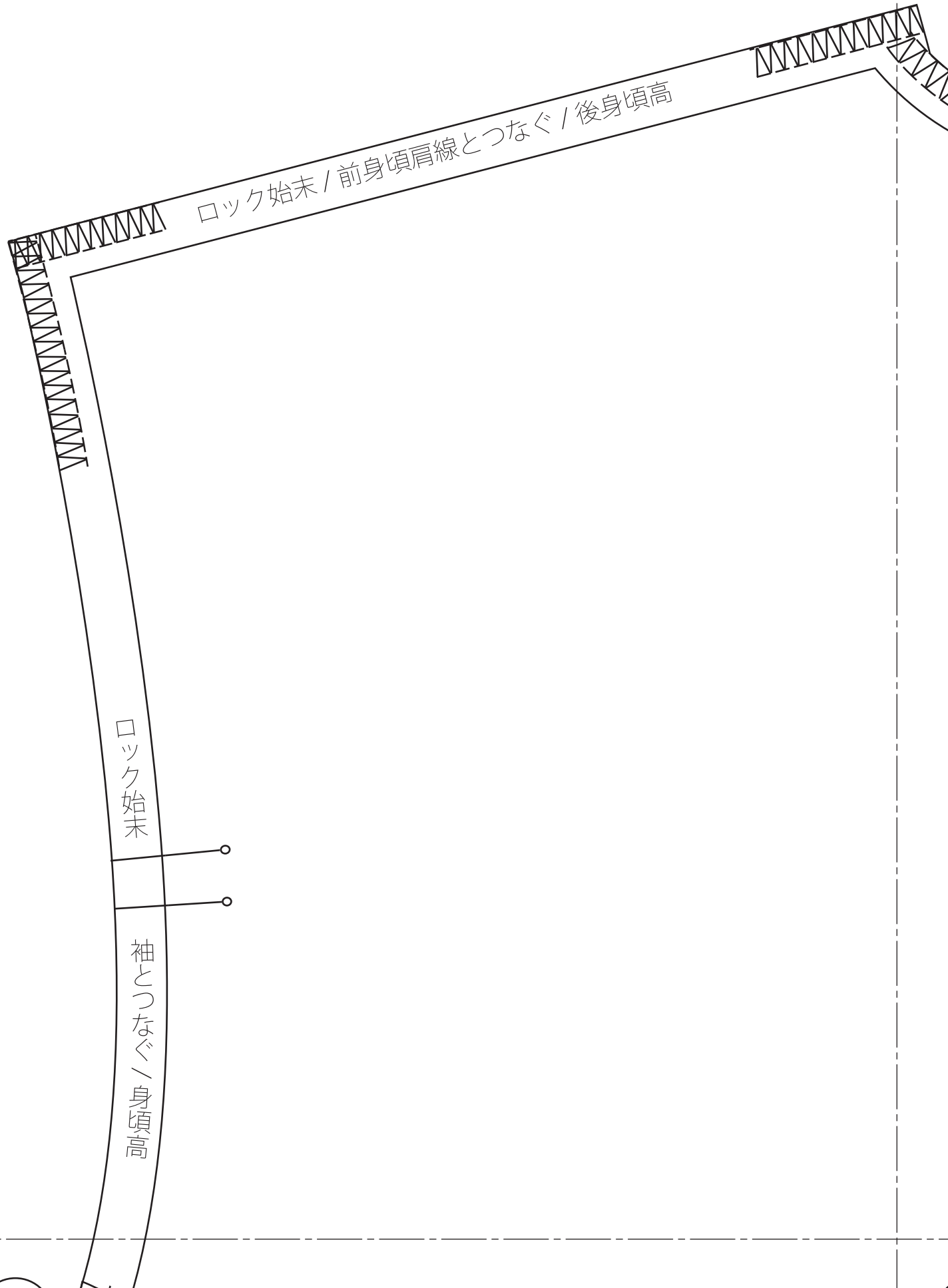

9

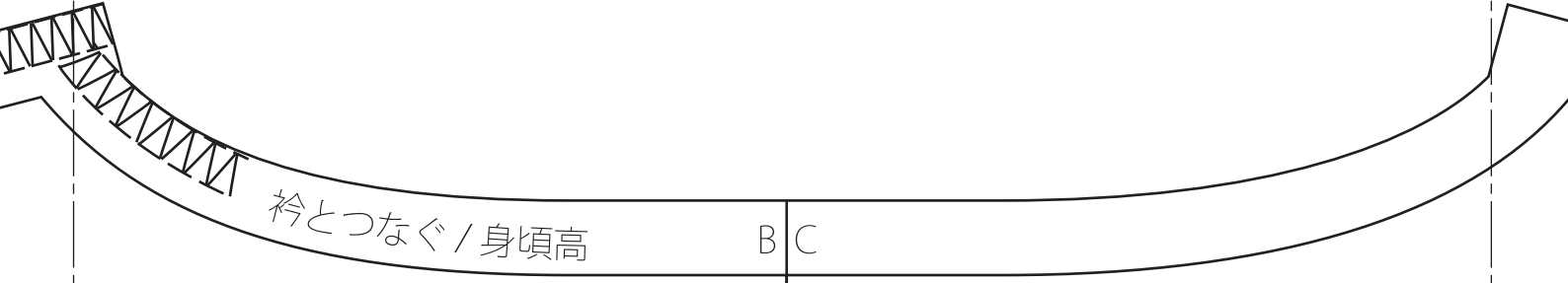

衿とつなぐ / 身頃高

B C

10

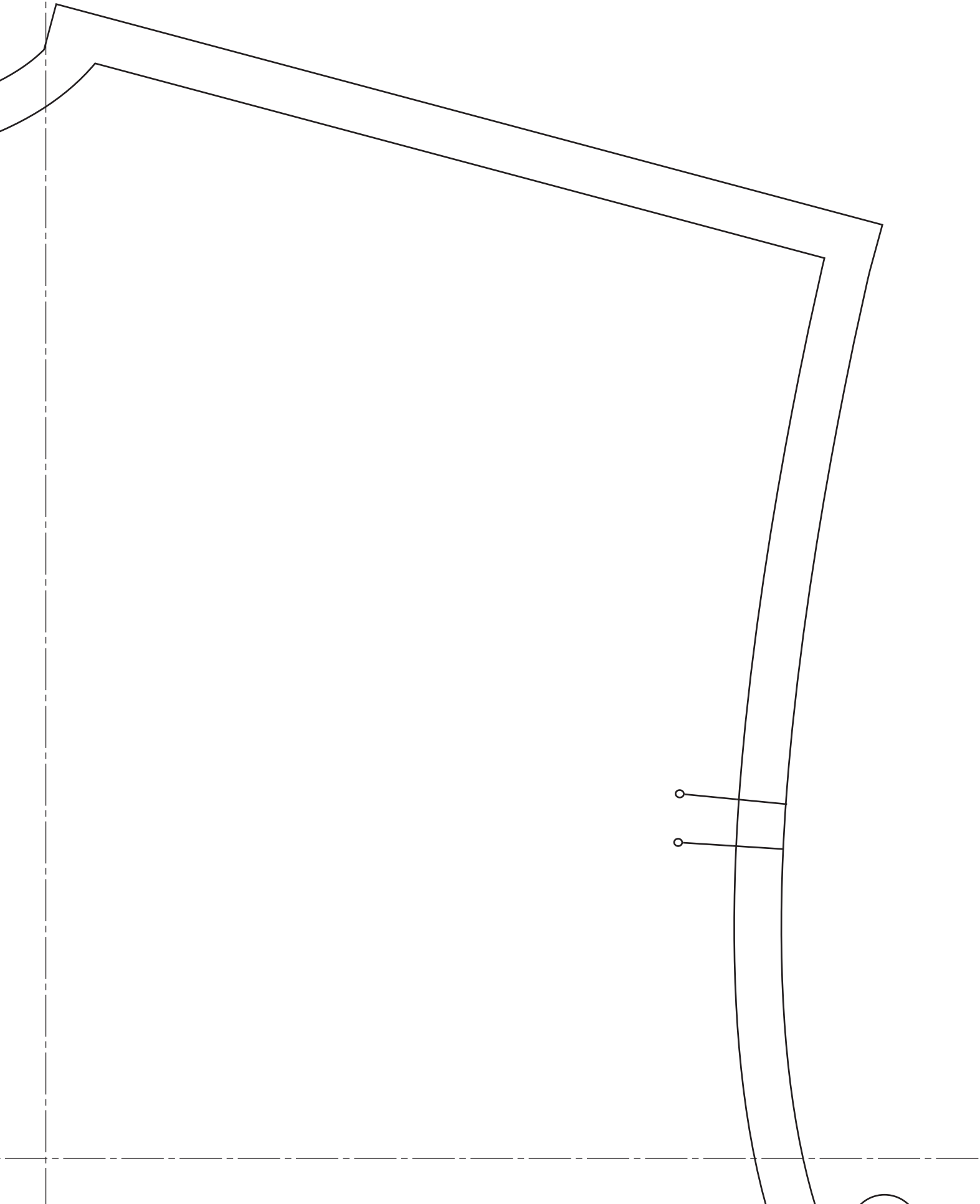

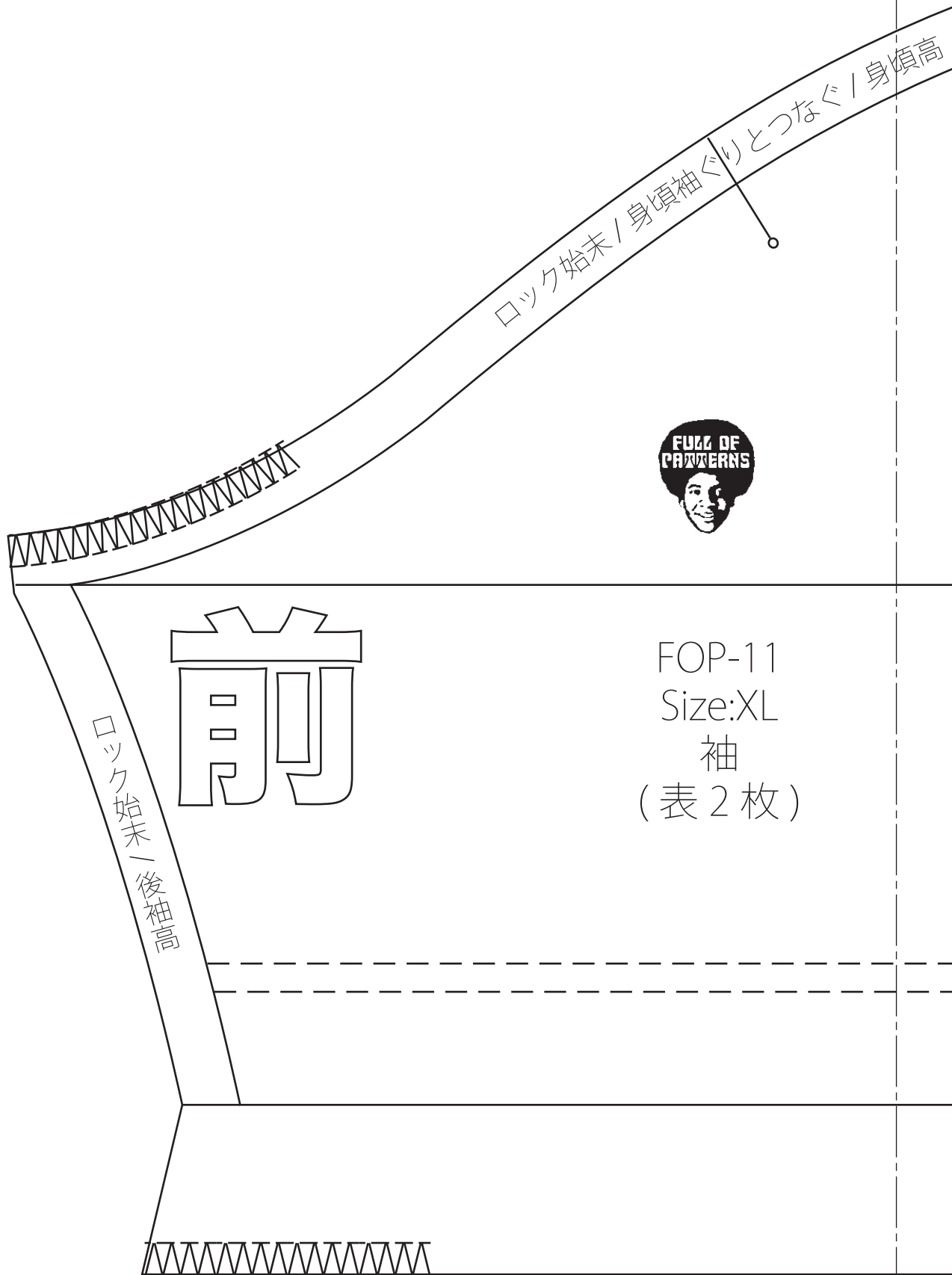

前



FOP-11
Size:XL
袖
(表 2 枚)

ロック始末 / 後袖高

ロック始末 / 身頃袖ぐり とつなぐ / 身頃高

12

身頃高

地の目

20mm+5mm
ダブルステッチ



二つ折り

ロック始末

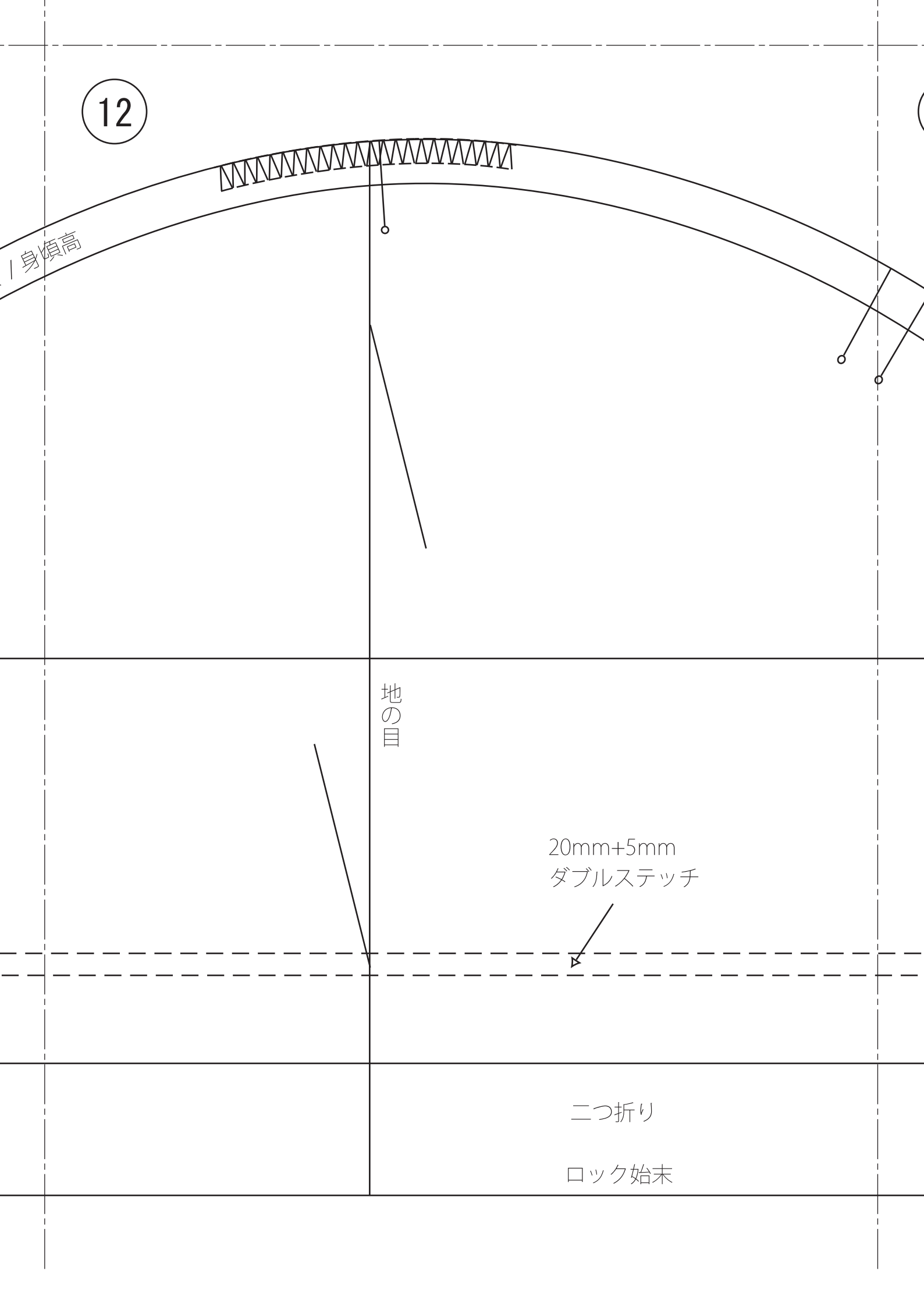

13

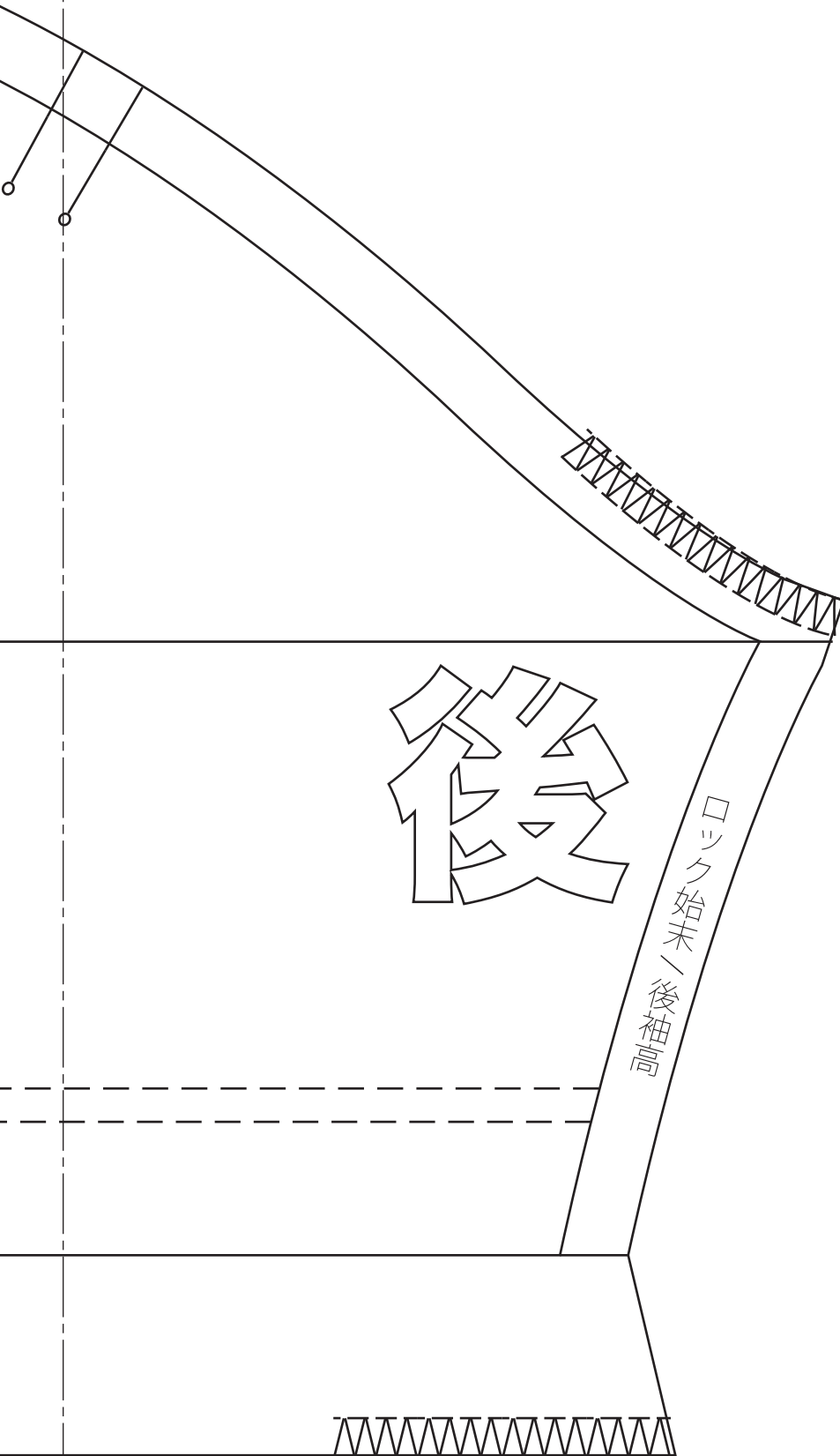



15

16

地
の
目





17

FOP-11
Size:XL
前身頃
(表 1 枚)

口ツク始末／前身頃脇線とつなぐ／後身頃高

18



FOP-11
Size:XL
後身頃
(表 1 枚)

ロック始末／前身頃脇線とつなぐ／後身頃高

19

地の目



| | |
|--|---------------------------|
| 地の目 | FOP-11/Size:XL 衿(リブ1枚) |
|  | ロック始末 / 身頃衿ぐりとつなぐ / 身頃高 |

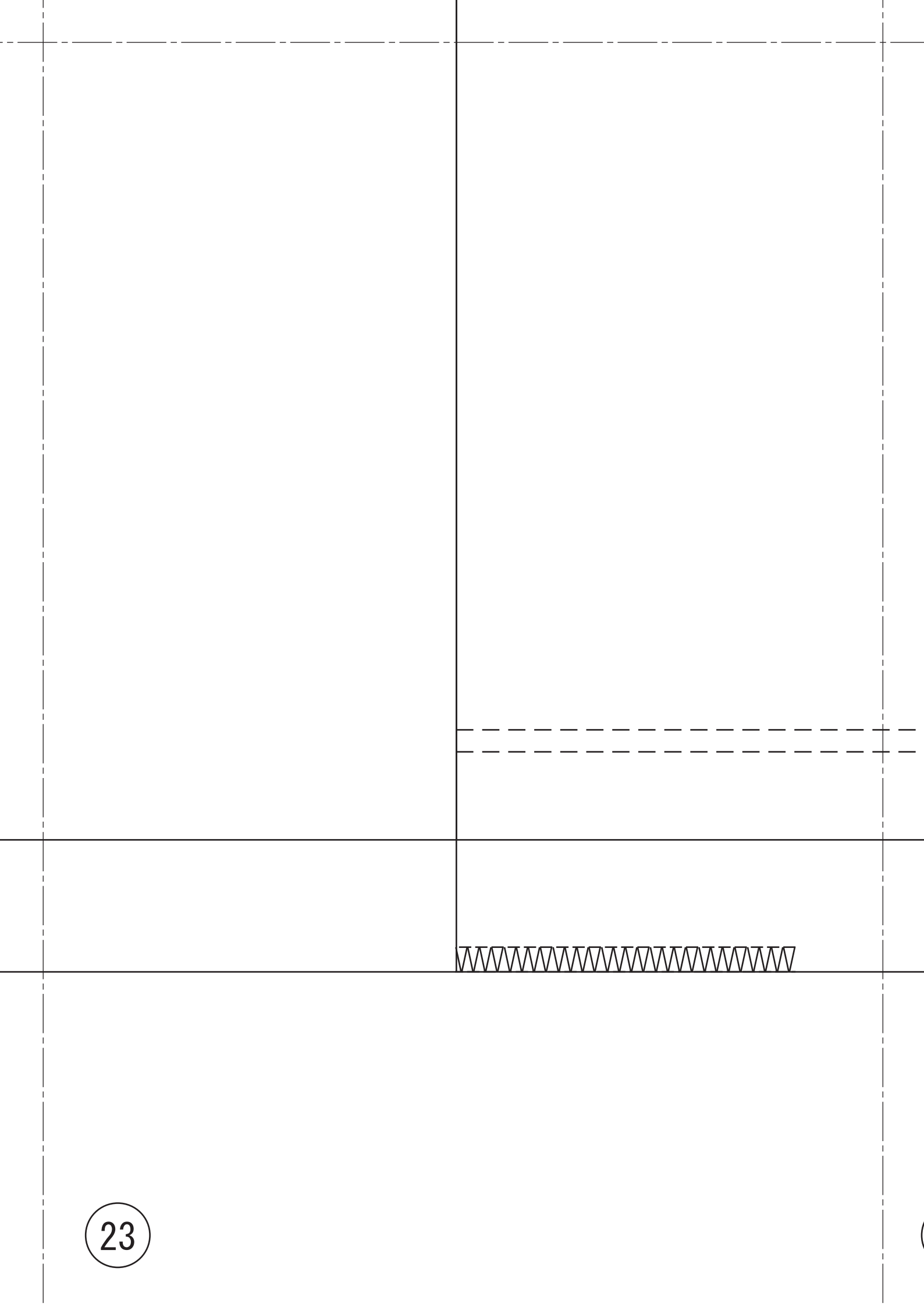

20mm+5mm
ダブルステッチ

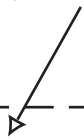

二つ折り

ロック始末



20mm+5mm
ダブルステッチ

二つ折り

ロック始末

